

FLY COMBAT MISSIONS WITH GEN. CHUCK YEAGER IN SIX DIFFERENT

P-51 MUSTANG VS MIG-15 F-4 PHANTOM VS MIG-21  
V-51 M... 190... F-86 SABRE VS MIG-15 F-4 PHANTOM VS MIG-21

PLANES FROM THREE HISTORICAL ERAS: WORLD WAR II, KOREA AND VIETNAM. CHOOSE

GEN CHUCK

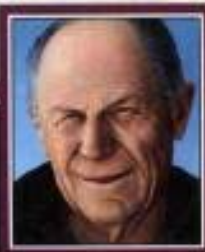

YEAGER'S

AIR

COMBAT

BY BRENT IVERSON

ELECTRONIC ARTS

SO ACTUAL HISTORICAL MISSIONS ON CREATE YOUR OWN

---

## A DIFFERENT KIND OF COMBAT

---

You've spent your life training to be a fighter pilot and dreaming of the day you'd actually get to fly. Hours, weeks, years invested in practice and training. All your hard work and time finally pay off and you develop into a world renown ace.

You owe a lot to the flying aces that came before you. The teachers who taught you excellence. You pay them back by teaching other green boys about what it takes to be a flying ace and the edge they need for fighting well. You put back what you took out so more pilots can train and defend the nation. There are, however, some selfish aces out there who don't give a damn about anyone else. These aces take all they can and say 'to hell with the pros who came before'.

Software publishing is much the same: most consumers pay for their software, but some green boys out there don't. They copy software and don't pay their dues to the teams responsible for bringing them the goods in the first place. When that happens, software companies don't have the money they need to keep turning out the best software they can — some even go under.

Electronic Arts is an ace in the field, giving you the best we can. Help us to keep putting out the best by stopping software piracy. As a member of the Software Publishers Association (SPA), Electronic Arts supports the fight against the illegal copying of personal computer software. Thank you for helping us in our effort to control software costs by eliminating software theft. Help us combat software piracy on the ground so we can keep bringing you combat in the air.

## TABLE OF CONTENTS

Quickstart to Air Combat .....	8
Tactical Overview .....	17
Mission Menus .....	19
Flying an Historic Mission .....	20
Ending an Historic Mission .....	23
Playing in Campaign Mode .....	25
Creating Custom Scenarios .....	25
Ending a Custom Scenario .....	28
Test Flight .....	29
Last Mission .....	31
Review Film .....	31
Instrument Check .....	33
Heads Up Display .....	34
Instrument Panel .....	36
In the Cockpit .....	41
Flight Stick Controls .....	42
Throttle Controls .....	44
Gear, Brakes, and Flaps .....	44
View Keys .....	45
Selecting Your Weapon .....	47
Targeting and Firing .....	47
Firing Missiles .....	48
Radar Warning Receiver .....	49
Countermeasures .....	50
Detecting by Radar .....	50
Quickly Locating Friendlies and Enemies .....	51
Navigating .....	52
Communications and Warnings .....	53
Damage .....	53
Ejecting .....	53
Time Compression .....	54
Blackouts and Redouts .....	54
Changing the HUD Color .....	55
Flight Menus .....	55

Flight Recorder .....	63
Playing Back Your Current Mission .....	64
Saving a Flight Recording .....	67
Reviewing a Previously Saved Flight Recording .....	68
Deleting Flight Recordings .....	69
Ground School .....	72
Airplane Movement .....	72
Altitude, Air Pressure, Oxygen .....	73
Four Forces .....	74
Three Measures of Turn .....	76
The Flight Envelope .....	77
Flight Performance Recovery .....	79
The Energy State .....	80
Flight School .....	83
Level Flight .....	84
Climb .....	84
Dive .....	84
Break .....	85
Take Off .....	86
Landing .....	86
Basic Maneuvers .....	91
Variations for Advanced Pilots .....	99
Gunnery School .....	107
Target Range .....	108
Flight Path .....	108
Deflection Angle .....	109
Holdover Angle .....	109
Leading .....	110
Gun Sight Type .....	110
The Secret to a Successful Strike .....	110
Answers to Copy Protection Questions .....	129-158



Fighter Tactics.....	113
Detection .....	114
Closing .....	117
Attack.....	118
Maneuver.....	120
Missile Evasion Techniques .....	121
Attacking Bombers .....	122
Attacking the Me-110.....	123
Ground Attack.....	123
Air Combat in Three Eras.....	125
America Enters World War II.....	126
Airplane Descriptions.....	128
Air Superiority over Korea .....	145
Airplane Descriptions.....	147
Air Combat in Vietnam.....	151
Airplane Descriptions.....	154
The Making of an Ace .....	159
Glossary .....	163
Appendix: HUD Messages.....	165
Suggested Reading .....	169
Selected Bibliography .....	170
About The Man .....	171
Index .....	172
Problems With The Game? — Technical Support.....	179

THE EXCITEMENT OF  
THOSE DOGFIGHTS  
NEVER DIMINISHED.

FOR ME,  
COMBAT REMAINS THE  
ULTIMATE FLYING EXPERIENCE.

— Gen. Chuck Yeager





# QUICKSTART TO AIR COMBAT



## WELCOME TO GENERAL CHUCK YEAGER'S AIR COMBAT

### COMMAND SUMMARY CARD

For instructions on installing *Air Combat* onto a hard drive or floppies, see the Command Summary Card included in the box.

The Command Summary Card also contains summaries and diagrams of *Air Combat's* keyboard commands.

### HOW TO USE THIS MANUAL

This manual is designed for easy use. All of the game controls and essential information are explained in five succinct chapters:

Mission Menus	Tells you how to select missions, test airplanes, and review films.
Instrument Check	Tells you how to read all the various instrument panels.
In the Cockpit	Tells you how to fly your airplane, change views, operate various on-board systems, and use <i>Air Combat's</i> special help features.
Flight Recorder	Tells you how to control the Flight Recorder.
Air Combat in Three Eras	Tells you the answers to the Copy Protection questions.

These sections are marked by a black border so you never have trouble finding the sections with the essential gameplay information.

The rest of the manual explains aerodynamics, fighter tactics, maneuvers, and gunnery skills, as well as providing the background for *Air Combat's* Historic Missions. These chapters all contain information and hints that can be directly applied to the game; however, you don't need to read them in order to take to the air and start shooting down airplanes.

### QUICKSTART

If you want to jump right into combat with a minimum of reading, use the Quickstart to *Air Combat*. The Quickstart will lead you through a custom mission in which you intercept B-17 bombers in a FW-190. You'll be introduced to *Air Combat's* flight controls as well as useful features like the Target Window and Flight Recorder.

### TACTICAL OVERVIEW

At the end of the Quickstart is a section called Tactical Overview. This section explains two basic concepts in air combat: speed and maneuverability. In the end, you'll understand how good tactics are more important than superior hardware.

### QUITTING AIR COMBAT

At any point in the game, you can exit to DOS by pressing Ctrl-C.

## QUICKSTART TO AIR COMBAT

### PREPARATIONS

Following the instructions under *Getting Started* on the Command Summary Card, load *Air Combat*. The Command Summary Card will guide you all the way up to the Main Menu.

You're going to need to know how to control your airplane, views, and weapons. Take a moment to skim over the flight and weapons control in the chapter called *In the Cockpit*. The sections you want to briefly review are:

Flight Stick Controls	p. 42
Throttle Controls	p. 44
Gear, Brakes, and Flaps	p. 44

### CREATE A CUSTOM MISSION

There are two kinds of missions in *Air Combat*: Custom and Historic. Custom Missions are combat scenarios that you design. You choose the airplanes, the opponents, and the tactical situation. Historic Missions are real missions drawn from three wars.

For this Quickstart, you're going to create a custom mission and fly it. Select Create Mission from the Main Menu.



### HOW TO "SELECT" OPTIONS

If you're using a mouse, select options by pointing the mouse cursor and clicking a mouse button.

If you're using the keyboard, press the **Tab** key to move the cursor to the different options. When the cursor is over the option you want, press the **spacebar**. To exit a menu and return to the previous screen, press **Esc**.

## CHOOSE THE FW-190

When you create a custom mission, you fill in the details of a war story like you're a veteran fighter jock recounting his exploits over mission whiskey. For this Quickstart, you're going to tell your pals at the O Club how you flamed some bombers in your hot German fighter. Select FW-190 as *your* plane.



## PLACE YOURSELF AT 10,000

The Focke-Wulf 190 A-8 is primarily a ground attack airplane. As such, it maneuvers best at low altitudes. Choose "10,000" feet.

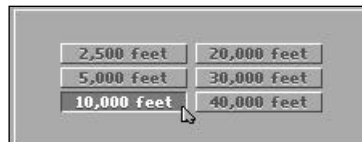

## TACTICAL POSITION

Your next step is to tell who had the advantage in the fight. To "jump" an opponent is to come barreling down on his head from behind and above. Since this is your first mission, you should take the advantage. Select "jumped."



## CHOOSE YOUR OPPONENTS

Now you need to say how many opponents there were. You're going to go up against bombers, so you can afford a few extra targets. Select "three."

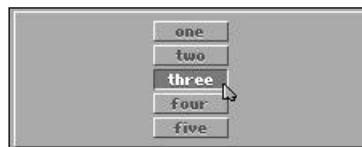

Three of what? You could duel any of the airplane types shown below. However, for the purpose of this Quickstart, your going to shoot down bombers. Select "B-17."

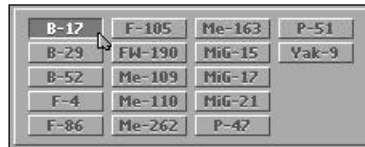

In any Custom Mission, you can fight up to three types of airplanes. You can choose 1-5 airplanes per type, for a maximum of 15 enemies. Whether you choose to be historically accurate or not is up to you — you can mix and match airplanes of different eras, if you like. However, you have enough targets for this mission, so choose ".".

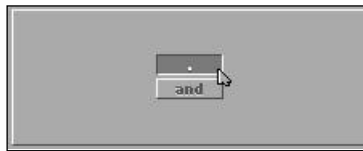

#### CHOOSE THE ENEMY'S EXPERIENCE LEVEL

Every pilot knows that the machine is only as good as the guy driving it. No war story is complete without saying whether your opponents were real pros or real pudknockers. In this mission, you're going up against some real lame ducks. Select "amateur."

You're now ready to begin the mission. You'll be placed somewhere behind and above the three B-17s. Select Done to begin.



+



If you need to pause the game at any point in this mission, press Ctrl-P.



**BEGIN THE MISSION**

You find yourself in the cockpit of a Focke-Wulf 190, diving on your opponents.

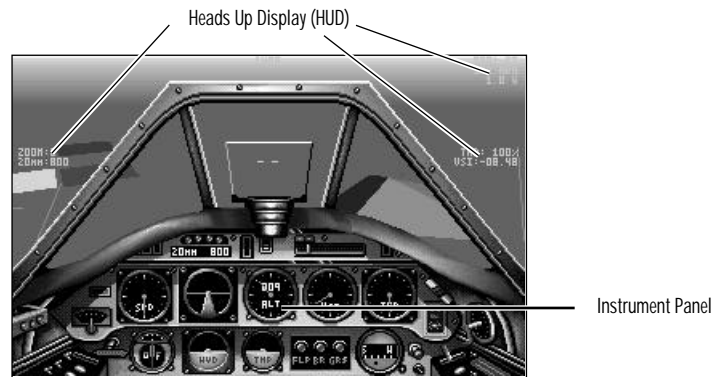
**HIDE THE INSTRUMENT PANEL WHEN SEARCHING**

In any combat situation, your first task is to find the enemy. Since you're "jumping" them, you know they're somewhere below and in front of you.



When looking for the enemy, it's usually a good idea to hide the Instrument Panel. This gives you a clearer view of what's in front of you. To hide the Instrument Panel, press backspace. (If later you want to display the Instrument Panel again, press backspace.)

**USE THE SCAN KEYS TO ROTATE YOUR VIEW**

If you can see the bombers right now, go to the next step. If you can't see the bombers right now, they're probably just a little ways off of the screen.

You can use the View Keys to look around your airplane, but since you know the enemy is somewhere in front of you, you should stay in Forward View and use the Scan Keys to scan left, right, and from side-to-side.

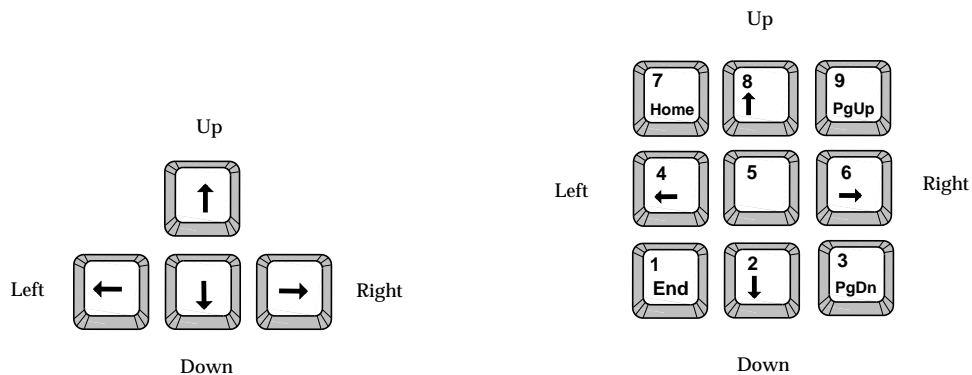

Extended 101 users: Use the cursor keys

AT keyboard users: Press Ctrl and use the numeric keypad.

## TARGET A BOMBER

Once you spot the bombers, you need to target one. *Targeting* helps you identify, pursue, and obtain valuable information on the enemy. (In Vietnam missions, targeting is essential for firing missiles.) You can only target an enemy plane while in Forward view. Note: When you target, you're still in the current view.

To target an enemy, press Enter. Joystick and mouse users, press button B.

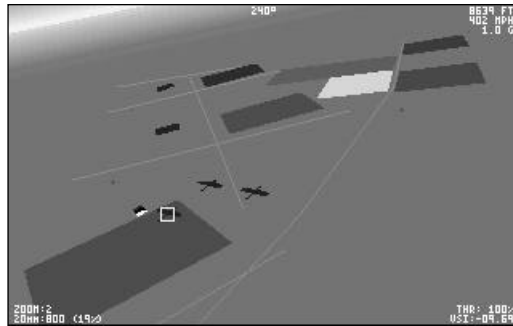

## LOOK STRAIGHT AHEAD



Once you've scanned a direction, it's difficult to scan back to where you're looking straight ahead. To return to your normal Forward View, press F1.

## TURN ON THE TARGET WINDOW



+



The Target Window option is located in the Help Menu; but rather than open the Flight Menus, use the shortcut command. Press Shift-3 to turn on the Target Window.

The Target Window gives you a view of the currently selected target and shows his relative position to you, *regardless of how far away he is*. Here is some other useful information the Target Window provides:

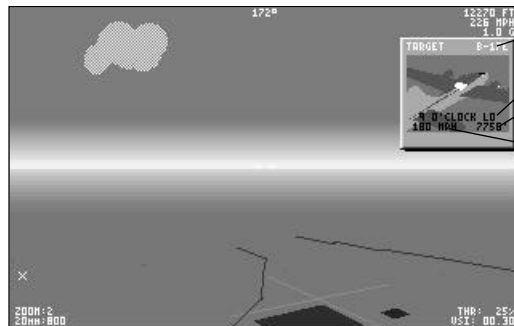

Aircraft type

Location

Distance

Speed

## INVINCIBILITY?!

The bomber's gunners are amateurs, so they're not very accurate. On the other hand, there are lots of them shooting at you. Give yourself the ultimate advantage — become invincible to enemy weapons!

Press Esc to bring up the Flight Menus. Press the right cursor key (→) to move the highlighted bar to the Help Menu. "Invincible" is already highlighted, so press Enter.



You're now invincible, so don't worry about those gunners. You'll still feel and hear every hit, but at least you'll have plenty of time to shoot down all three bombers.

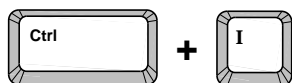

Note: Many of the Flight Menu options have shortcut commands assigned to them. Rather than bringing up the Flight Menus, you could have simply pressed the shortcut command, Ctrl-I, to select Invincibility.

#### DIVE ON THE B-17S



You're ready to attack. Because you want plenty of time to shoot at the bombers, you don't want to pick up too much speed in the dive. Press F to lower your flaps. This will slow your airplane down while you're in the dive and keep you from exceeding your maximum speed limit.

To begin your dive, push your flight stick forward (see "Flight Stick Controls" in *In the Cockpit*).

#### GET A BOMBER IN YOUR GUN SIGHTS

The trick now is to get the bomber in your sights. You may have to roll right or left to get a bead on the bomber (see "Flight Stick Controls" in *In the Cockpit*).

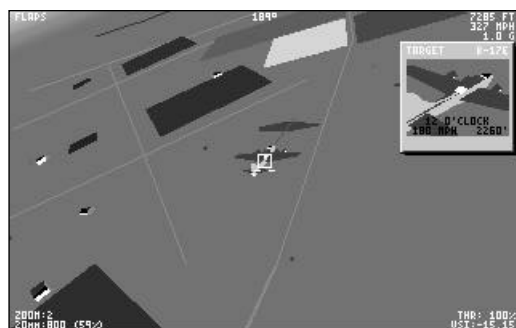

#### WHEN YOU'RE IN RANGE, FIRE

In the lower left corner of the Heads Up Display is some weapons information: "20mm :800 (%)." The "20mm" is the currently selected weapon — a 20 mm MG 151/20 cannon. "800" is the number of rounds this weapon has. The percentage sign is your average percentage chance to hit this target at this range.

Watch the percentage closely. When it rises above 20%, start firing. To fire, press the spacebar. Joystick and keyboard users, press button A.

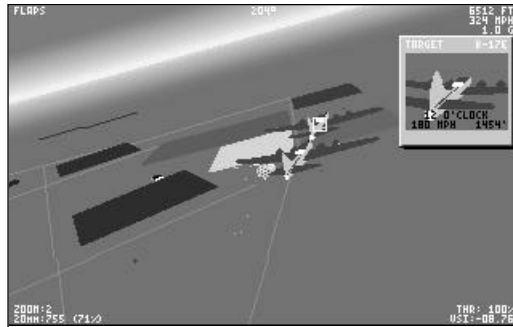

Wait until your chances of hitting are good

As you fire, you'll have to pull back on the flight stick to keep the bombers in sight. Maneuvering and firing is rarely easy, but it must be learned.

**MOP 'EM UP**

Since your fighter is traveling at over 300 mph, you'll eventually overtake your target. You'll have to circle around for repeated passes.

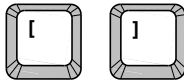

If you run out of ammo, you'll have to switch to one of the FW-190's other weapons. To select a different weapon as the current one, press the right bracket (]) or left bracket ([) key.

**REVIEW THE MISSION**

Once you've blasted the bombers out of the sky, you can review the mission with *Air Combat's* Flight Recorder. To bring up the Film Playback, press P.

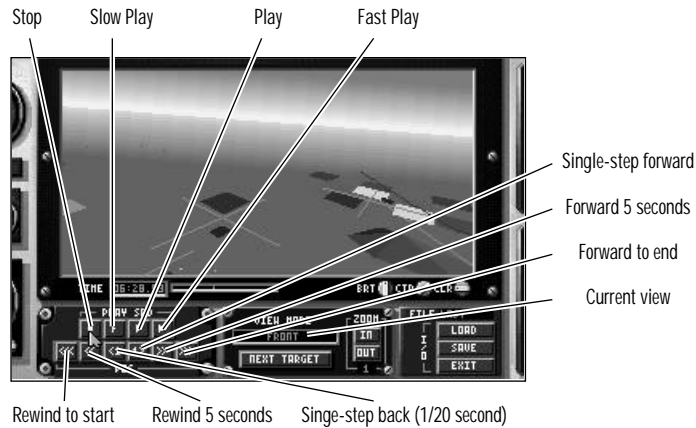

Use the View Keys to change your view of the action. Below is a summary of some of *Air Combat's* more important View Keys (see View Keys in *In the Cockpit* for a more complete listing).



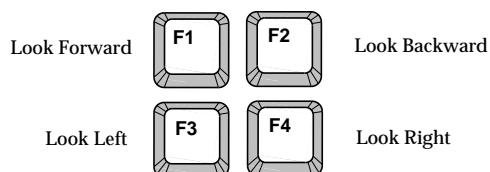

When you're done experimenting with the flight recorder, select EXIT to return to the mission. Once you return to the mission, you can practice some basic maneuvers (see *Basic Maneuvers*).

#### EJECT AND END THE MISSION

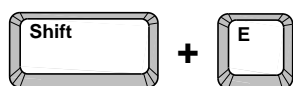

When you're done practicing flying, press Shift-E to eject. (There are plenty of Focke-Wulfs where that one came from.) The mission will end automatically when you touch the ground.

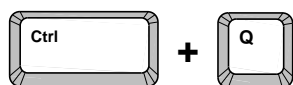

If you want to end the mission sooner than that, press Ctrl-Q.

#### STATS SCREEN

When the mission ends, the Stats screen appears. Take a look at your bullet accuracy. Don't worry if you didn't hit much — there are plenty of airplanes for you to practice your gunnery skills (for hints that could improve your shooting, see *Gunnery School*.)



---

## TACTICAL OVERVIEW — FIGHTER VS. FIGHTER

---

Though often deployed against ground targets, the fighter is above all an airplane killer. Its role is to seek out enemy airplanes and shoot them in the air, thereby defending home targets from enemy air attack or clearing the way for an air or ground offensive.

The bombers you attacked in the Quickstart mission were one kind of prey. But though bombers provide unique challenges for the attacking fighter, they don't make for a stimulating dogfight. Fighter vs. fighter combat, on the other hand, is dynamic, fast-moving, and exciting. It's also complex, which is why there is no way to provide a Quickstart that explains how to win a dogfight. Nonetheless, the basic concepts of air combat can be explained, and while knowing them may not win you an air battle, *not knowing* them may kill you.

Two basic concepts discussed here are *speed* and *maneuverability*. Superior speed has obvious uses. The airplane that's significantly faster can not only get within firing range faster, it can use its speed advantage to make lightning attacks. It also gives the pilot the luxury of easily disengaging from combat if the situation gets rough — something the slower aircraft can do little to control.

Superior maneuverability is also important. At its simplest level, dogfighting is a series of attempts to maneuver your weapons into a position to shoot at an enemy fighter, all the while denying him a chance to do the same. An attack from behind is best, since an enemy with forward-firing weapons can't shoot from the rear. It's this need to get onto the enemy's tail that makes maneuverability so important. A more tightly turning airplane gives the pilot a considerable advantage over his opponent.

Speed and maneuverability are to a large extent *opposed* to each other. The faster airplane can't turn as sharply as the slower one, but the slower airplane can't climb as quickly. As you'll learn, altitude is a big advantage in air combat. Both speed and maneuverability have their advantages.



# MISSION MEMOS





## MISSION MENUS

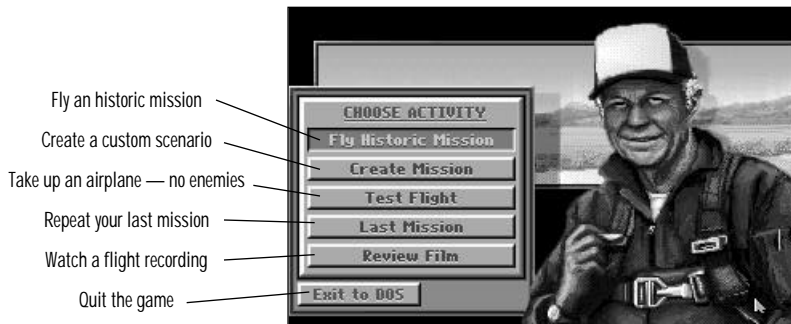

## SELECTING OPTIONS FROM THE MISSION MENUS

## Mouse Users

To select an option, point the mouse cursor and click a mouse button.

## Keyboard Users

Press the Tab key to move the cursor to the different options.

When the cursor is over the option you want, press the spacebar. To exit a menu and back up to the previous screen, press Esc.

In addition, most options in the Mission Menus have keys assigned to them — pressing that key selects the option for you. The key is usually the first letter of the option. For example, pressing F while viewing the Main Menu selects Fly Historic Mission.

See the *Command Summary Card* for a complete listing of the keys for each Game Screen.

## FLYING AN HISTORIC MISSION



*You're there to shoot the enemy down. It doesn't matter if he's a bomber or fighter, if you have missiles or guns. That's one thing that's true in every war.*

Though the historic missions have dates next to them, you can fly them in any order you like. But if you want a challenge, you can set the game up so you have to fly the missions in each era as part of a larger campaign. See "Playing in Campaign Mode" in this chapter.

1. Choose Fly Historic Mission from the Main Menu.



2. Choose which conflict you want to participate in.



Choose Exit to go back to the Main Menu.

A single small square below the mission descriptions indicates an easy mission. Two small squares indicate a moderately difficult mission, and three tell you that the mission is especially difficult.

A check (✓) by the mission indicates that you've accomplished the mission fully without any help (see "Ace's Challenge" under "Ending an Historic Mission" in this chapter.)

3. Choose the mission you want to fly.

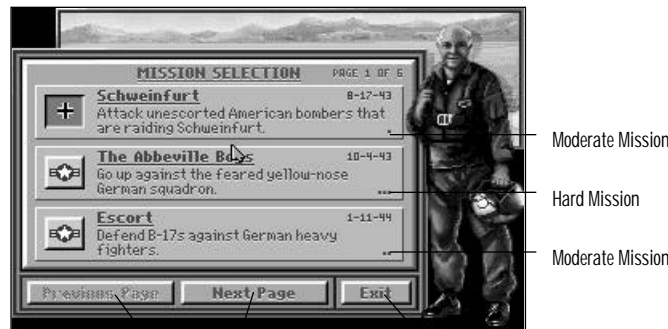

Moderate Mission

Hard Mission

Moderate Mission

Choose Next Page and Previous Page to review other missions.

Choose Exit to go back to the Conflict Selection screen.

4. Set the Difficulty level for this mission.

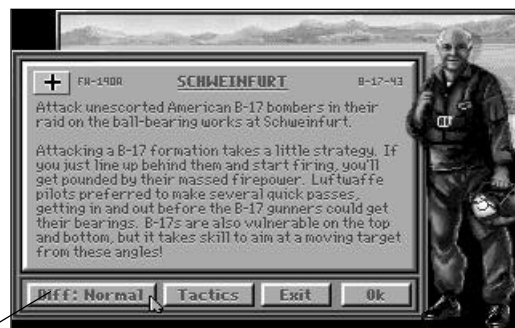

To change the Difficulty level, move the cursor to the Diff: button and press a mouse button or the spacebar.

## DIFFICULTY LEVELS

Difficulty levels affect the skill and experience of your opponents.

**EASY**

Most of the opponents you face are green. They tend to stay on the defensive and are relatively inaccurate with their weapons. Call this a *target-rich environment*.

**NORMAL**

You face both skilled and unskilled opponents. Only good judgement will tell you if the guy you're facing is a turkey or an eagle.

**HARD**

Expect to see mostly experienced pilots in the air. They'll do everything in their power to get you in their sights and when they shoot, they'll hit.

**EXPERT**

You're up against the cream of the enemy's air force. It'll take a lot of maneuvering to get the enemy in sight — that is, if he doesn't shoot you down first.

5. Choose Tactics to compare your airplane with the enemy's. This does *not* select airplanes for the mission — it allows you to compare two airplanes before you head out.



Choose ← → to cycle through the airplanes on the left.  
 Choose ↑ ↓ to cycle through the airplanes on the right.  
 Choose OK to return to Mission Description

The Tactics screen compares your fighter's weapons, ceiling, and maximum weight with that of your opponent. The arrows indicate which plane has the advantage over the other.

6. Choose OK to start your mission.

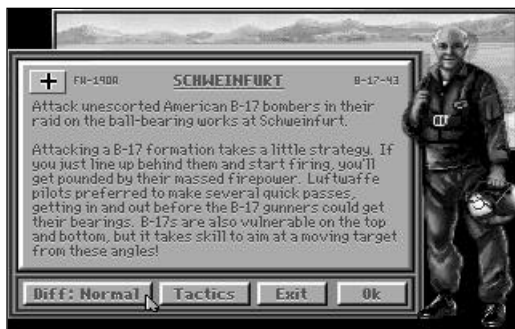

## 7. Fly your historic mission.



## TAKE THE ACE'S CHALLENGE

Here's something else to shoot for. Take the Ace's Challenge. For each mission you must:

- Achieve the mission objectives
- Don't use *any* help features. The help features include any of the options in the Help Menu. Keyboard and Mouse Users: Because it's more difficult to aim when controlling your airplane with a mouse or the keyboard, you can select Easy Aiming from the Help Menu and still take the Ace's Challenge.
- Land on the runway of your home base, cut throttle to 0%, and come to a complete stop

If you're in a mission and you're not sure whether you've used any help features, press Esc to bring up the Flight Menu. If a square appears on the right end of the menu bar, you've used a help feature; no square means you haven't.

Note: Once you've started a mission with a help feature active, you're automatically disqualified from the challenge. If a square did appear in the menu bar, you must start the mission again.

If you successfully do all of the above, a check (✓) appears by the mission's date.



## ENDING AN HISTORIC MISSION

You can end an historic mission anytime. There are three ways to end a mission:

- Press Ctrl-Q. Alternately, you can press Esc, and then select End Mission from the ? Menu.
- You can fly to your home base, land on the runway, cut the throttle to 0%, and come to a complete stop (see "Navigating" in *In the Cockpit*).
- Eject out of your airplane. You can only do this safely at speeds of 500 mph or less and at an altitude of 300 ft or more.



When you've accomplished your mission objectives, a MISSION ACCOMPLISHED message appears at the top of the HUD.

If the Yeager Window is on, Yeager delivers the good news.



If you didn't accomplish the mission objectives, it's assumed that you successfully bugged out and got home.

#### MISSION DEBRIEFING

When you're done flying an historic mission, Yeager tells you how you did.

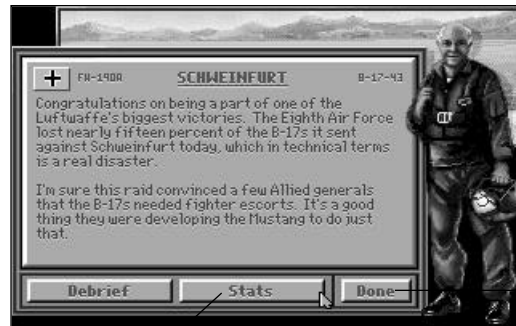

Select Done to return to the Main Menu.

Select Stats to see details of your mission.

#### Stats Screen

The Stats screen provides information on kills and losses, accuracy with your weapons, how long the mission lasted, and your airplane's condition.



Select Debrief to see Yeager's message again.

Select Done to return to the Main Menu.



## PLAYING IN CAMPAIGN MODE

When you choose to do a campaign, you're signing up for the long haul — you're committing yourself to fly and fight over 15 missions in order.

To play in Campaign Mode, you must use the campaign parameter (CAMPAIGN) when typing the command line. See "Starting Features" in *Loading Air Combat* on the Command Summary Card. To start a new campaign, type "Yeager Campaign".

### CAMPAIGN RULES

There are six pages of missions in each war. You must successfully complete the current missions before you can go to the next page.

Success means *achieving the mission objectives* as Yeager described them. If the mission objective is to protect bombers, then you must protect bombers; if your mission was to strafe ground targets, then you must destroy any ground targets in your patrol sector.

Don't use *any* help features or your victories will not count and you won't be able to progress to subsequent pages of the campaign. The help features include any of the options in the Help Menu. Keyboard and Mouse Users: Because it's more difficult to aim when controlling your airplane with a mouse or the keyboard, you can select Easy Aiming from the Help Menu and still complete a campaign.

## CREATING CUSTOM SCENARIOS



*Now and then, we get together and lie to each other about our exploits in the old days...*

This is your chance not only to tell some outrageous war stories, but to actually go up and fly them. You can set up swarms of inferior opponents for a big turkey shoot, or put yourself in the worst possible situation and see if you can claw your way out of it. Try giving yourself a prop airplane and letting a jet bounce you.

You begin with the words "There I was in my..." You fill in the details. At any point in this sequence, you can select Back Up or press the backspace key to return to the previous screen.

1. Choose Create Mission from the Main Menu.



2. Choose the airplane you want to fly.



3. Choose the altitude you want start at.



4. Choose your tactical position.



#### Tactical Positions

**EASY**

Your tactical position determines where you are in relation to your opponent.

You're above and behind your opponent, and he's unaware of your presence. You have the tactical advantage.

**SAW**

You're heading toward each other at roughly the same altitude, completely aware of the other. You're on equal footing with your opponent.

**WAS JUMPED BY**

Your opponent is somewhere above and behind you, prepared to attack. He has the tactical advantage.

5. Choose a number of opponents.



6. Choose the type of aircraft your opponents are flying.



7. Choose "." to end the sentence, or choose "and" to add more opponents to the scenario.



8. Choose the experience level of your opponents.



#### Experience Levels

In general, inexperienced opponents will be less aggressive in a dogfight and will try to evade you (diving, jinking, etc.). Experienced pilots will confront you if possible and do everything possible to get a good bead on you. If you manage to get on the tail of an experienced pilot, he'll break, climb, twist, and dive in order to shake you. Experienced pilots are also better marksmen and will use their weapons more efficiently.

9. Choose Done to fly your custom mission.



#### ENDING A CUSTOM SCENARIO

You can end a custom scenario anytime. There are three ways to end a mission:

- Press Ctrl-Q. Alternately, you can press Esc, and then select End Mission from the ? Menu.
- You can fly to your home base, land on the runway, cut the throttle to 0%, and come to a complete stop (see "Navigating" in *In the Cockpit*).
- Eject out of your airplane. You can only do this safely at speeds of 500 mph or less and at an altitude of 300 ft or more.

#### Stats Screen

The Stats screen provides information on kills and losses, accuracy with your weapons, how long the mission lasted, and your airplane's condition.



Select Done to return to the Main Menu.

## TEST FLIGHT



*Maximum power, lift, and maneuverability are achieved mostly by instinctive flying: you know your horse.*

Select Test Flight to take up any of the six featured fighters in *Air Combat*. You can also get performance and armament data as well as Yeager's comments on any of the fighters encountered in the game. (For info on bombers and liaison aircraft, see the aircraft recognition manuals in the historic era description sections in this manual.)



←, →

Select the arrow buttons to cycle through the aircraft.

3d/2d

Select the 3d/2d button to switch between a two-dimensional bitmapped view of the airplane and the three-dimensional polygon view you see in the game. In 3d view you can rotate the airplane to view it from any possible angle.





To rotate the airplane, use the mouse or Tab to move the cursor onto the window. Press the spacebar or a mouse button.



Click in box with cursor arrow to rotate airplane

#### Exit

Select Exit to return to the Main Menu.

#### Fly

You can fly any of the six featured planes in a *non-hostile environment*. Select Fly when viewing the featured planes:

- P-51D Mustang
- FW-190
- F-86 Sabre
- MiG-15 Fagot
- F-4E Phantom II
- MiG-21 Fishbed

The Fly option is greyed out when viewing any airplanes other than the six featured ones.

When you test fly an airplane, the Location Menu appears in the Flight Menu. The Location Menu lets you quickly change your location so you can test your airplane's performance at different altitudes and practice takeoffs and landings. The locations are:

<b>On Runway</b>	On the runway, ready for take off.
<b>Final Approach</b>	Final approach for landing
<b>10,000 ft</b>	10,000 ft up
<b>40,000 ft</b>	40,000 ft up

There are three ways to end a mission:

- Press Ctrl-Q. Alternately, you can press Esc, and then select End Mission from the ? Menu.
- You can fly to your home base, land on the runway, cut the throttle to 0%, and come to a complete stop (see "Navigating" in *In the Cockpit*).
- Eject out of your airplane. You can only do this safely at speeds of 500 mph or less. At higher speeds, there's a chance you could rip your head from your shoulders!

## LAST MISSION

Select Last Mission to bypass the mission screens and go directly to the last mission you flew (whether Historic, Custom, or Test Flight). The mission will start without introduction, so keep on your toes.

## REVIEW FILM

Review Film lets you load and watch any previously saved flight recording. Once you select Review Film, a select file box appears:

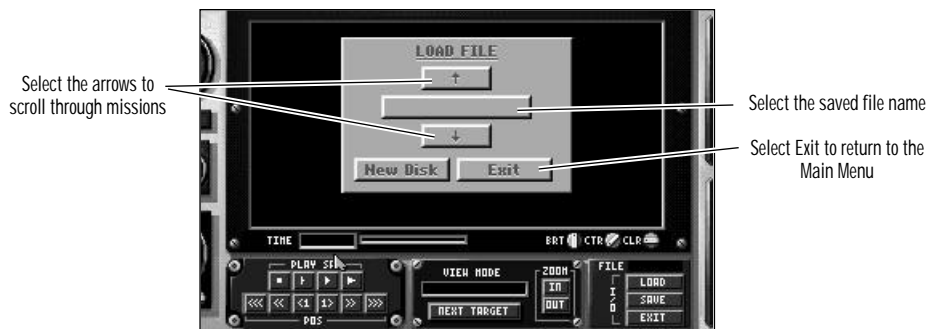

Select the mission you want to load. For more details on saving and loading missions, see *Flight Recorder*.



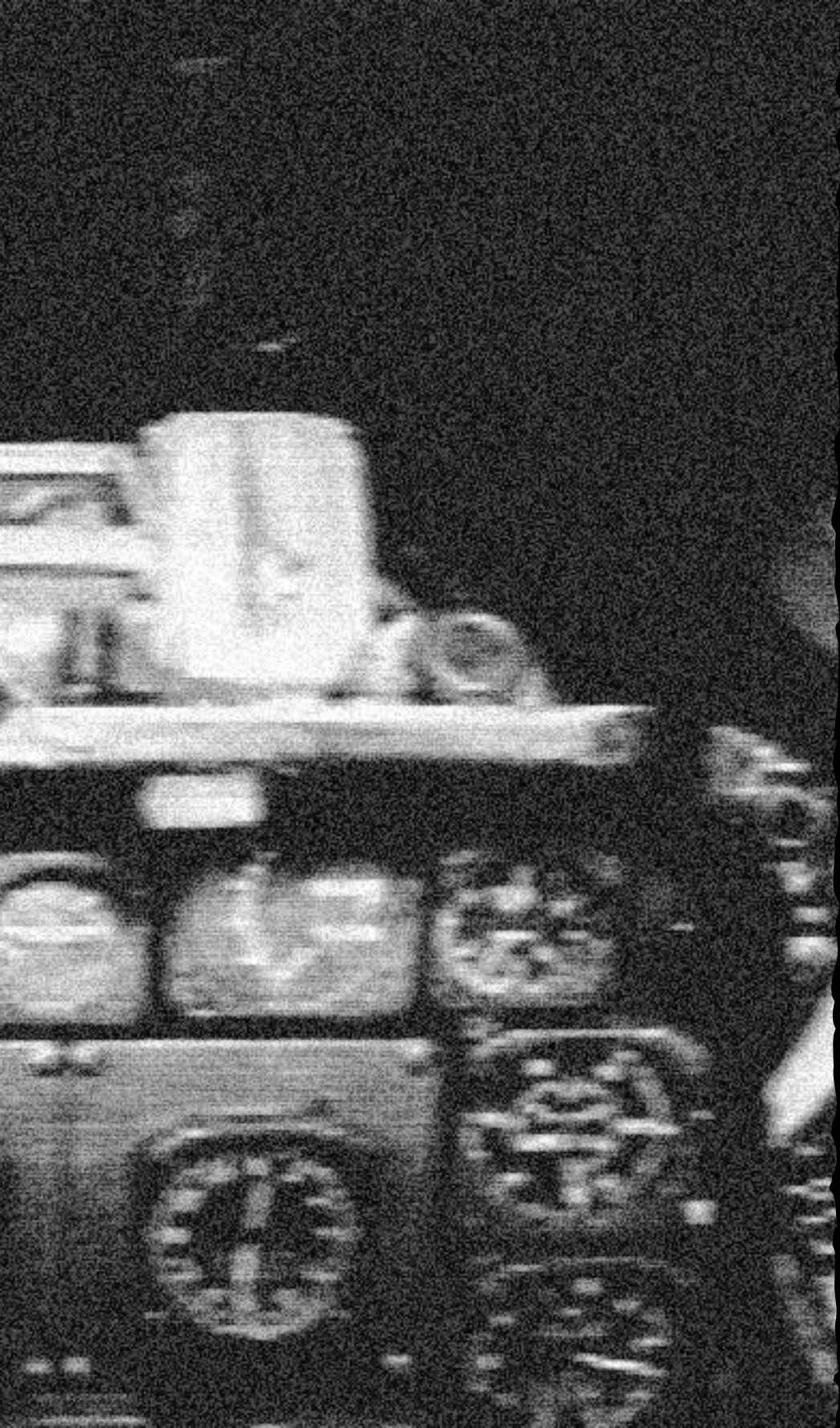

# INSTRUMENT CHECK



## INSTRUMENT CHECK

### HEADS UP DISPLAY

The Heads Up Display or HUD is a transparent sheet spread across the glareshield upon which critical information is electronically projected. The HUD reduces the need to look down at your instruments. Although HUDs of this complexity were not used until recently, every airplane in *Air Combat* can have one. To turn the HUD on or off, press Ctrl-F or select Flight Info from the Graphics Menu.

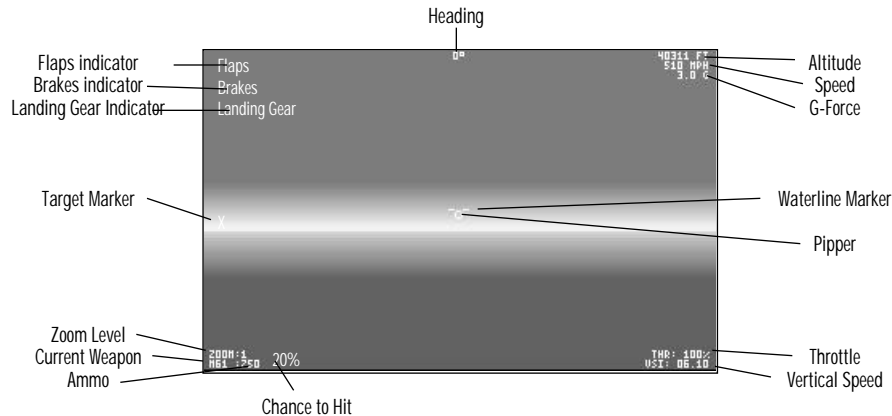

#### ALTITUDE

Indicates your altitude above sea level.

#### TRUE AIR SPEED

This displays your forward velocity

#### HEADING

The compass direction you're heading. 0° is north, 90° is east, 180° is south, and 270° is west.

#### TARGET MARKER

The target marker indicates where the target is off of the screen. This is the shortest direction you would have to fly to get into a firing position. Note that the shortest route is not always the *best* route — for example, if you're following the target marker at low altitudes, you could possibly turn into the ground. For details on using the Target Marker, see "Maneuver" in *Fighter Tactics*.

#### PIPPER

The pipper is the gun sight for Korean and Vietnam era fighters (for details on using the gun sights and the pipper, see *Gunnery School*).

#### WATERLINE MARKER

Indicates your airplane's attitude relative to the ground. When the waterline marker is parallel to the ground, you are flying on a straight course. If the waterline marker is above the horizon (in the blue), you're climbing. If it's below (in the green), you're diving.

#### LANDING GEAR INDICATOR

Indicates that your landing gear is down. Press G to raise or lower landing gear.



**FLAPS INDICATOR**

Indicates that your flaps are down. Press F to raise or lower flaps. For details on flaps, see *Ground School*.

**BRAKE INDICATOR**

In the air, indicates that your air brakes are on. On the ground, this shows that your wheel brakes are set. Press B to set your air brakes or wheel brakes. For details on air and wheel brakes, see *Ground School*.

Note: WW II era airplanes do not have air brakes. Pressing B only sets or releases their wheel brakes.

**G-FORCE**

The number of g's you and your airplane are experiencing. A g is the basic unit of load factors on your airplane — it's often used to measure the severity of a turn. For details on the effects of g's on flight, see *Ground School*.

**TIME COMPRESSION**

Press T to toggle Time Compression on and off. When Time Compression is on 2x, events happen at twice their normal rate, or 4x where events happen at four times their normal rate (hitting T a third time turns Time Compression off, and the symbol disappears from the HUD). Time Compression is useful for reducing the amount of time it takes to reach destinations. But be careful; you'll have to react twice as fast to enemy attacks.

**ZOOM LEVEL**

The level of visual magnification — 1x, 2x, 4x, 8x, 16x, and 32x. The default zoom level setting is 2. To increase visual magnification, press +. To decrease visual magnification, press -.

**CURRENT WEAPON**

The weapon currently activated by the weapon control. To change the currently selected weapon, press "[ " or " ] " on the keyboard. Note: Some fighters only have one type of weapon. For details on weapon control, see "Selecting Your Weapon" in *In the Cockpit*.

**AMMO**

The ammo (in rounds) available for the currently selected weapon.

**CHANCE TO HIT**

Your percentage chance to hit the selected target with the current weapon.

**THROTTLE**

Current throttle setting, displayed as a percentage of maximum engine power. If your afterburners are on, THR: will be replaced by AFT:. (Note: Afterburners are only available in Vietnam era airplanes.) If your engine is damaged, you may not be able to increase throttle to 100%.

**VERTICAL SPEED**

The vertical speed of your aircraft in thousands of feet per minute. This number is positive when ascending, negative when descending.

**LANDING READINESS**

When you are on your final landing approach, you need to lower your flaps, reduce your vertical speed and your air speed, and lower your landing gear. When you've lowered your gear and your flaps and reduced your air speed enough to land, the symbol "xxx" appears next to your vertical speed indicator, at which time it is safe to touch down.

**RADIO COMMUNICATIONS/WARNING MESSAGES**

Radio communications and warning messages appear at the top of the screen. For details on communications and messages, see "Communications and Warnings" in *In the Cockpit*.

## INSTRUMENT PANEL

The Instrument Panel displays the necessary information for controlling your aircraft. The Instrument Panel shown below belongs to the F-4 Phantom. The Instrument Panels of *Air Combat's* other aircraft are illustrated at the end of this chapter.



### LANDING GEAR INDICATOR

Shows whether the landing gear is up or down. Press G to raise or lower landing gear. The green light indicates the landing gear is up. The red light indicates the landing gear is down, enabling safe landing.

### FLAPS INDICATOR

Shows whether the wing flaps are up or down. Press F to raise or lower flaps. For details on flaps, see *Ground School*. The green light indicates the flaps are up. The red light indicates the landing flaps are down.

### BRAKE INDICATOR

In the air, this shows whether your air brakes are on or off. The green light indicates the brakes are off. The red light indicates the brakes are on. On the ground, the red light indicates that your wheel brakes are set. Press B to set your air or wheel brakes. For details on air brakes and wheel brakes, see *Ground School*.

Note: WW II era airplanes do not have air brakes. Pressing B only sets or releases their wheel brakes.

### CHAFF/FLARE INDICATOR

The number of chaff and flare bursts you have left. Press 0 to drop flares and 9 to drop chaff. For details on firing chaff and flares, see "Countermeasures" in *In the Cockpit*.

### RADAR MONITOR

Displays objects seen by your active radar. Press R to turn your radar on and off. For details on using radar, see "Detecting by Radar" in *In the Cockpit*.

### WAYPOINT INDICATOR

Indicates the direction you need to fly to get to the next waypoint. Press W to change the next waypoint you want to head toward. See "Navigating" in *In the Cockpit* for more details.

### SPEED INDICATOR

Registers the speed of the airplane in miles per hour (mph).

### ARTIFICIAL HORIZON

Shows the wing's degree of bank. Artificial horizons in Korean and Vietnam era cockpits show the degree of pitch as well.

**ALTIMETER**

Measures the height in feet of the airplane above sea level. *Air Combat's* airports and open terrain are at sea level.

**RADAR WARNING RECEIVER (RWR)**

The RWR is a passive detection device that senses any active radar currently aimed at your airplane. For details on RWR, see "Radar Warning Receiver" in *In the Cockpit*.

**HEADING INDICATOR**

Like a compass, this shows which direction the plane is flying — north, south, east, west, or points between. For navigation tips, see "Navigating" in *In the Cockpit*.

**VERTICAL SPEED INDICATOR**

Indicates whether the airplane is climbing, descending, or in level flight. The rate of climb is measured in thousands of feet per minute.

**FUEL GAUGE**

Indicates how much fuel you have left. When you run out of fuel, your engine quits.

**CURRENT WEAPON**

The currently selected weapon and the number of rounds left.

**TEMPERATURE WARNING GAUGE**

Shows when your engine temperature is above normal. At normal engine temperature, this gauge is at 0. At maximum temperature, your engine will soon overheat and catch on fire.

**OIL PRESSURE GAUGE**

Indicates oil pressure in your engine. If your engine is damaged, oil pressure may drop and your engine will overheat.

**THRUST GAUGE**

Indicates your thrust. A green light on in the F-4 indicates that your afterburners are on. No light on in the F-4 indicates no afterburners. In the MiG-21, a red light indicates that your afterburners are on. A green light on in the MiG-21 indicates no afterburners.

**HYDRAULIC FUEL GAUGE**

Monitors the pressure in your hydraulic system. If your hydraulic system is damaged, pressure will drop. In hydraulically-controlled airplanes (F-4, F-86, and MiG-21), low hydraulic pressure limits the effectiveness of the flight stick. In all *Air Combat* airplanes, a loss of hydraulic pressure prevents you from dropping flaps, air brakes, and landing gear.

COCKPITS

P-51 MUSTANG

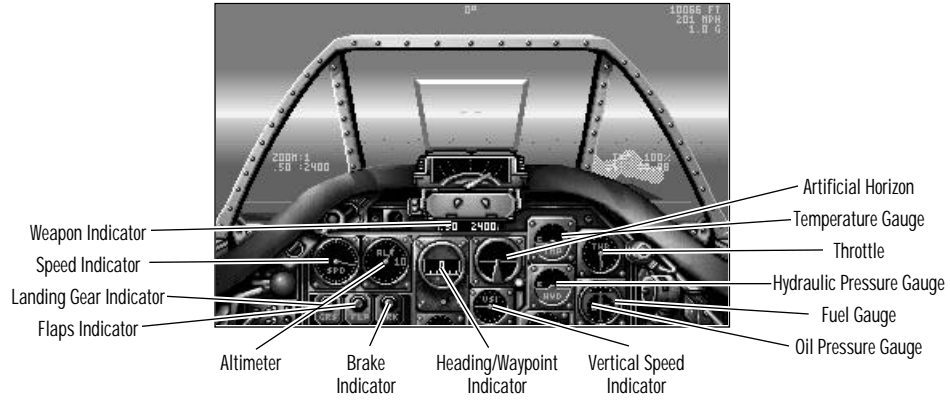

FOCKE WULF-FW190

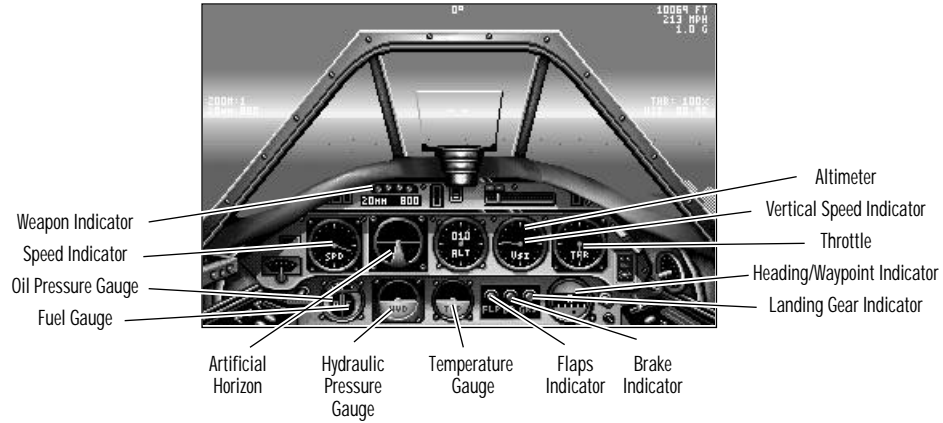

F-86 SABRE

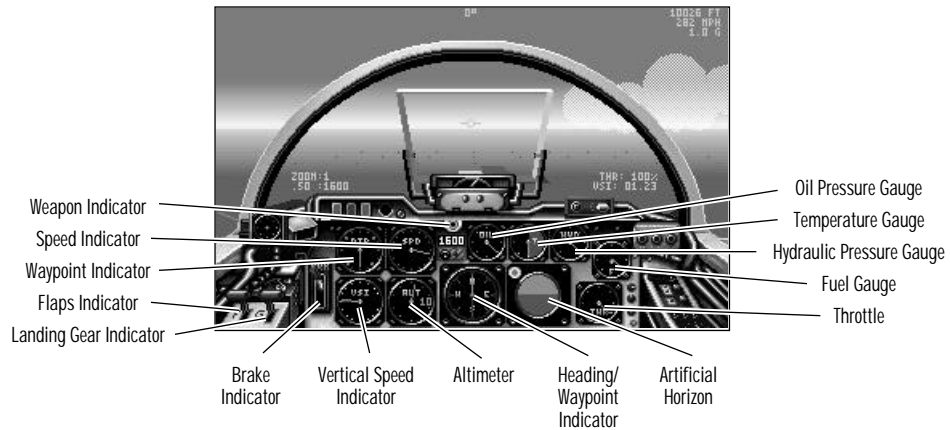



MIG-15 FAGOT

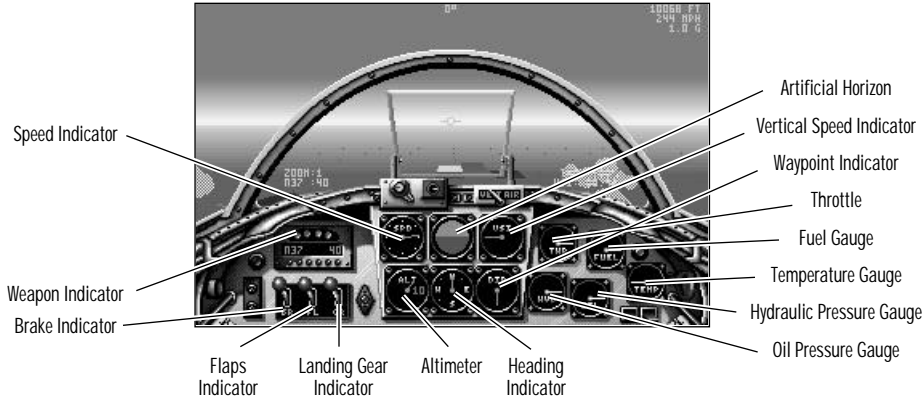

F-4 PHANTOM II

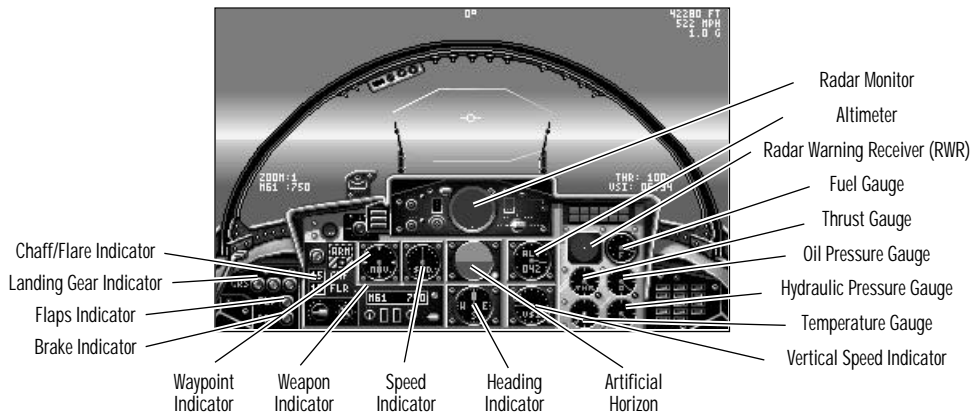

MIG-21 FISHBED

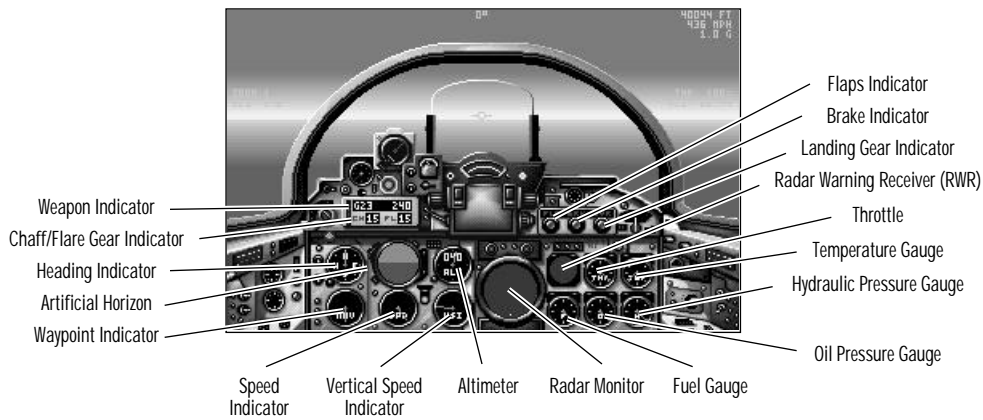



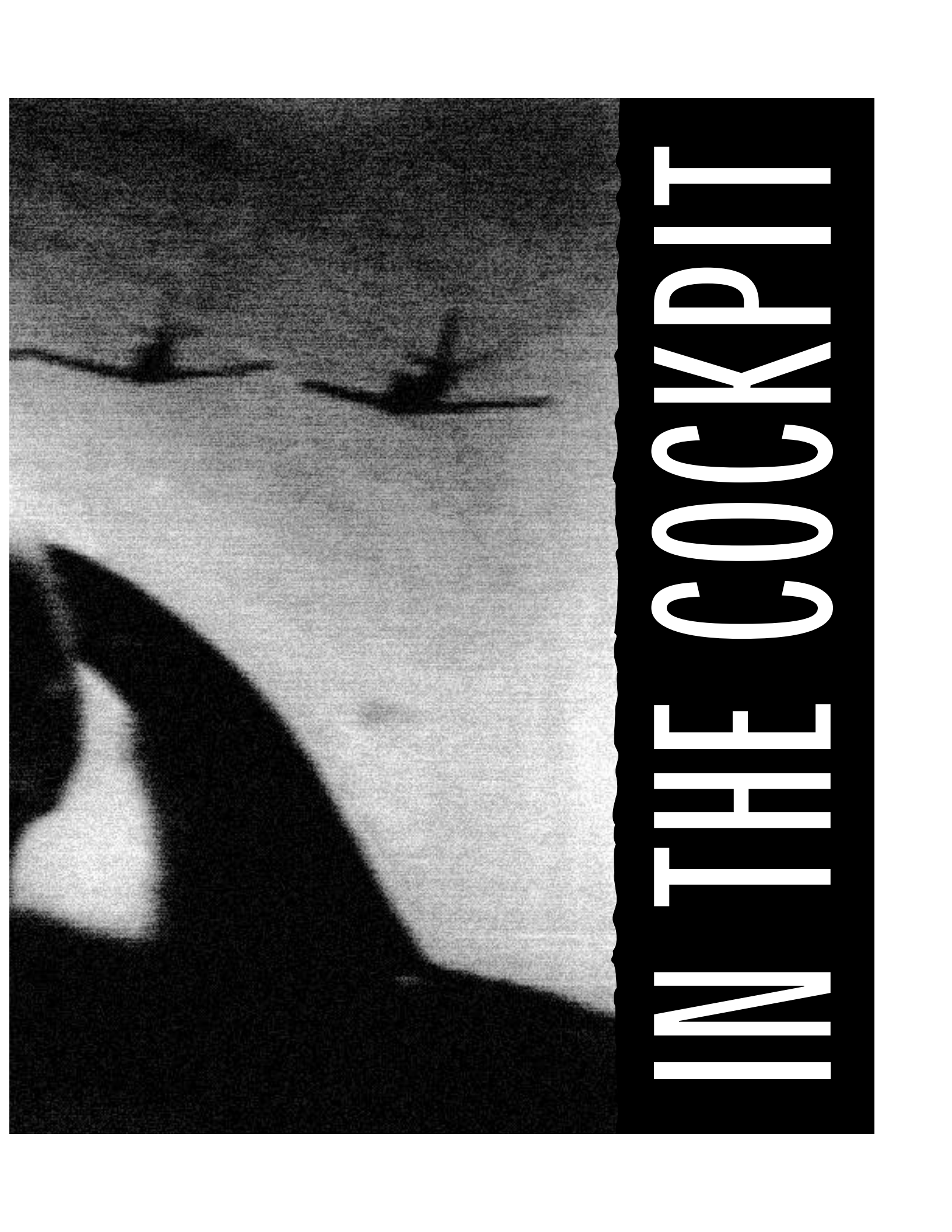

**IN THE COCKPIT**

## IN THE COCKPIT



*Concentration is total. You remain focused, ignoring fatigue or fear, not allowing static into your mind. Up there, dogfighting, you connect with yourself. That small, cramped cockpit is exactly where you belong.*



## SOME IMPORTANT GAME KEYS

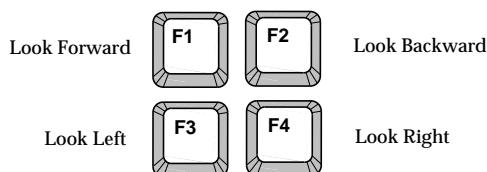

Pauses the game and brings up the Flight Menus. Options on the Flight Menus let you configure the game to your liking. See Flight Menus in this chapter.



Display/hide Instrument Panel.



+



Pauses the game. Press any key to continue.



+



End mission.

## FLIGHT STICK CONTROLS

A pilot uses the flight stick to roll, climb, and dive. In *Air Combat*, the flight stick automatically coordinates the rudder to produce even turns.

You can control the flight stick with a joystick, mouse, or the keyboard. To change your control device, press Esc to bring up the Flight Menus. From the System Menu, select Joystick, Keyboard, Mouse, or Hi-Res Mouse.

## JOYSTICK

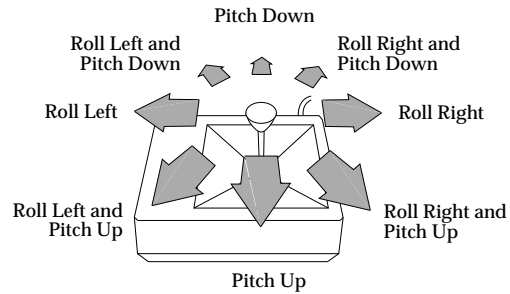

## Calibrating Your Joystick

If you notice your airplane isn't flying level but tends to "drift," you need to recalibrate your joystick. To calibrate your joystick:

1. Press Esc to bring up the Flight Menu.
2. Select Joystick from from the System Menu.
3. At the prompt, move your joystick to the upper left corner and press a button.
4. At the prompt, move your joystick to the lower right corner and press a button.
5. Return the joystick to center.

## MOUSE

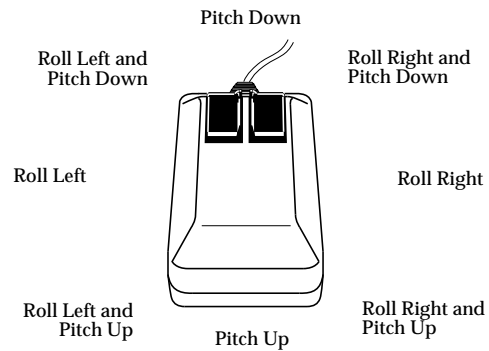

## Centering the Flight Stick

To center your flight stick, press / (or 5 on the numeric keypad).



## KEYBOARD

Use the numeric keypad to control your airplane. Hold down a key to initiate a roll, climb, dive. When you release the key, the flight stick automatically centers.

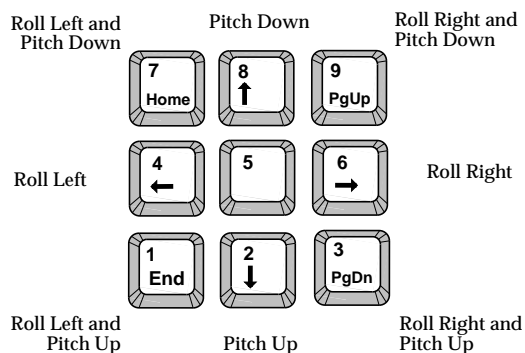

## THROTTLE CONTROLS

The throttle controls the amount of energy your aircraft's engine produces. This energy is measured as a *percentage* of your engine's *total potential output*. The throttle can only be controlled using the keyboard.

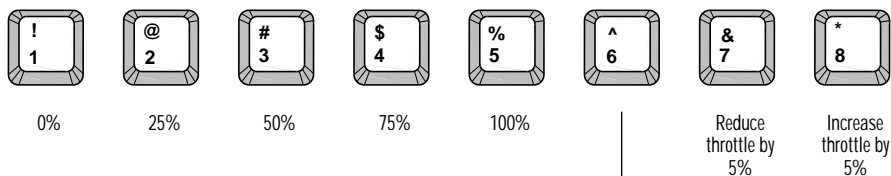

Increase throttle to 100% and turn on afterburner (only applies to Vietnam era airplanes). To turn off the afterburner, press any other throttle key.

## GEAR, BRAKES, AND FLAPS

Your gear, brakes, and flaps are controlled with the keyboard.

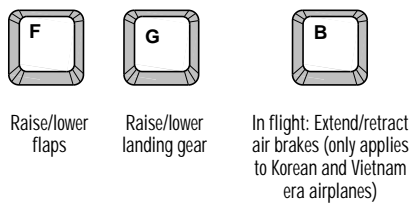

On the ground: Set/release wheel brakes

For detailed explanations of these flight controls, see *Ground School*.

## VIEW KEYS

*Air Combat's* 18 view keys not only make for dashing cinematic sweeps of aerial acrobatics — they have tactical uses as well. While patrolling, combat pilots must constantly scan the sky for bogeys. In a dogfight, visual contact with the enemy is critical — both during the attack and when evading the enemy.

## DISPLAY/HIDE INSTRUMENT PANEL

If the Instrument Panel is currently displayed, press backspace to hide it. If it's hidden, press backspace again to display it.

## COCKPIT VIEWS

The Cockpit Views let you quickly view your surrounding. When searching for a bandit, you can press all six keys in rapid order and have a pretty good chance of spotting him. That being said...

Stay alert! The area below and in back of your airplane is obstructed by your airplane. This is a blind spot the enemy would love to hit you from!



Forward Look ahead. This is your "normal" view



Back Look over your tail at what's behind you



Left Look over the left wing



Right Look over the right wing



Up 45° Look up at a 45° angle from Forward View



Down 45° Look down at a 45° angle from Forward View



You can only target opponents from Forward View. Note that you can still target opponents while *scanning* in Forward View (see "Scan Keys" in this section).

## EXTERNAL VIEWS OF YOUR AIRPLANE











External Views can be used to get a wider view of your airplane and its surroundings. External Back View is especially useful if you're worried about visitors at 6 o'clock low.















+



External Forward Behind your airplane, looking forward.

	+		External Back	In front of your airplane, looking back.
	+		External Right	External looking right.
	+		External Left	External looking left.
	+		External below	From below looking up.
	+		External above	From above looking down.

## OTHER VIEWS

		Plane → Target	View of your airplane (foreground) in relation to current target (background). You must have a target to select this view (see "Targeting and Firing" in this chapter).	
		Target → Plane	View of current target (foreground) in relation to your airplane (background). You must have a target to select this view (see "Targeting and Firing" in this chapter).	
		Map	A map of the area with waypoints (see "Navigating" in this chapter for details on using the Map).	
		Fly-By	View from a fixed point below your airplane as it flies overhead. Press Ctrl-Pg Up to elevate your view of the airplane as it passes by. Press Ctrl-Pg Dn to lower your view.	
	+		Target's Cockpit	In the cockpit of the current target. You must have a target to select this view (see "Targeting and Firing" in this chapter).
	+		External Target	Behind your current target. You must have a target to select this view (see "Targeting and Firing" in this chapter).
	+		Circling	Circling external view of your airplane.
	+		Missile	External view from behind your missile as it speeds through the air. You must have fired a missile to select this view (see "Firing Missiles" in this chapter).

**SCAN KEYS**

Use the Scan Keys to rotate your view. You can scan from any of the 18 views.

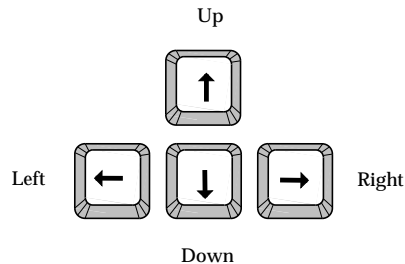

**AT Keyboard Users:** If you're controlling the flight stick with a joystick or mouse, use the cursor keys on the numeric keypad to scan. If your flight stick is controlled from the keyboard, press Ctrl with the cursor arrow keys to scan.



If you're using the keyboard to control the flight stick, press Ctrl with the cursor arrow keys to scan.



When you scan, use F1 to return to forward view quickly.

**SELECTING YOUR WEAPON**

Except for the P-51 and F-86 (with their powerful complements of six .50 caliber machine guns), all of your aircraft have multiple weapons on board. The current weapon is fired when you press the fire button. Use the following keys to select the current weapon.



Select next weapon



Select previous weapon

**TARGETING AND FIRING**

You can use the joystick, mouse, or keyboard to target and fire.

**JOYSTICK USERS**

The joystick buttons control targeting and firing. Joysticks vary greatly — experiment to see which button on your joystick is button A and which is button B.

A button — Fire currently selected weapon.

B button — Select target to right of current target.



Target object closest to aiming crosshair

**MOUSE USERS**

The mouse buttons control targeting and firing.

Left button — Fire currently selected weapon.

Right button — Select target to right of current.



Target object closest to aiming crosshair

**KEYBOARD USERS**

Fire Currently Selected Weapon



Target next object to right of current target



Target object closest to aiming crosshair

**FIRING MISSILES**

In Vietnam scenarios, you have air-to-air missiles at your disposal as well as guns. Unlike your guns, you must target an enemy aircraft and get a lock on it before you fire the missile.

**INFRARED-GUIDED MISSILES**

*Infrared-guided* (or heat-seeking) missiles are sensitive to infrared radiation emitted by your target's jet engines (they're not sensitive enough to lock onto prop-driven engines). The F-4 Phantom is armed with four AIM-9 Sidewinder heat-seeking missiles. The MiG-21 carries the East's copies of the Sidewinder — four K-13 Atolls. The infrared missiles of the Vietnam era were not as sensitive as those used today. To get a proper target lock, Vietnam pilots had to be more or less staring down their opponent's tailpipe.

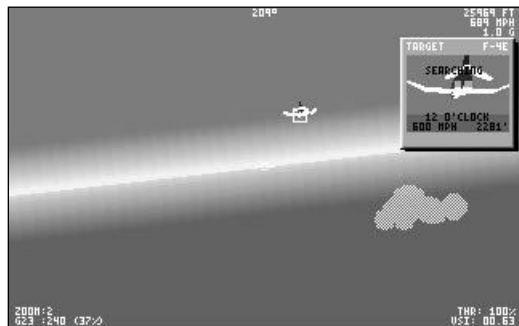

Get on the target's six so his engines are clearly visible. Select your infrared missile as your current weapon. A low buzzing noise tells you that the missile is active and ready.



When the diamond appears, your missile has a lock on the target (the buzzing noise becomes higher pitched). Watch your percentage chance to hit and keep in mind that Vietnam era missiles were highly inaccurate.

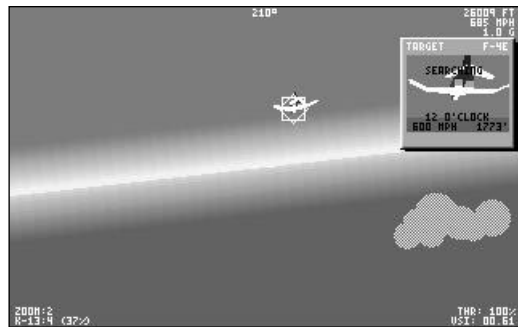

For missile tactics, see "Attacking with Missiles" in *Fighter Tactics*.

#### RADAR-GUIDED MISSILES

*Radar-guided* missiles use your on-board radar to home in on your opponent. The F-4 Phantom is armed with four AIM-7 Sparrow radar-guided missiles. The MiG-21 has no radar-guided missiles.

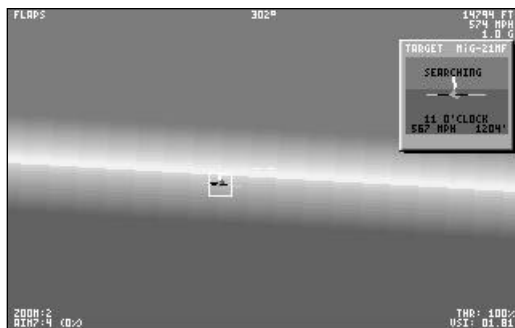

Once you've targeted your opponent, turn on your radar (press R). Select your radar-guided missiles as your current weapon. A high-pitched beeping noise tells you that the missile is active and ready.

When the diamond appears, your missile has a lock on the target (the beeping noise turns into a long "hum"). Watch your percentage chance to hit and keep in mind that Vietnam era missiles were highly inaccurate — especially the radar-guided Sparrow.

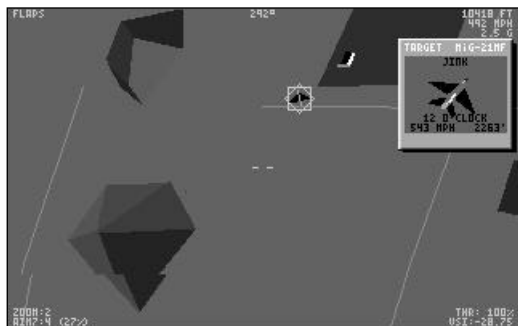

For missile tactics, see "Attack" in *Fighter Tactics*.

#### RADAR WARNING RECEIVER

The Radar Warning Receiver (RWR) is a passive detection device that senses any active radar in the vicinity of your airplane. An RWR blip could indicate friendly or enemy search radar, or it might be announcing an imminent radar-guided missile attack. All Vietnam era aircraft are equipped with these "fuzzbuster" units.

Your airplane appears in the center of the RWR screen. Enemy airplanes will blink depending on their current "state" or intentions:

**Searching** — Enemy planes that are searching for a target will typically flash their radar about once every two seconds. They appear on your RWR monitor as *slow-blinking dots*.

**Tracking** — Opponents that are tracking a target will leave their radar on. They're displayed as *solid dots* on the RWR screen.

**Preparing** — Enemies with a radar missile lock on your airplane are displayed as *fast-blinking dots*. When targeted by an enemy plane, your airplane's radar warning alarm is sounded (a low-pitched beeping sound). If the missile has been launched, the active missile alarm is sounded (a high-pitched beeping sound). Note: There is no audible warning for heat-seeking missile attacks.

RWR sensitivity radiates from your airplane in a sphere. Depending on the range of your opponents, you may want to increase or decrease the range of this sphere. If opponents are at long range, decrease RWR magnification. If opponents are in close proximity, increase magnification so you can get a better sense of their relative locations.



If blips are clustered around your aircraft, increase magnification.



Increase RWR magnification



Decrease RWR magnification

## COUNTERMEASURES

Countermeasures are the procedures you take to avoid missiles fired at your aircraft. The countermeasure you take depends on the type of missile being launched.

A *chaff* cartridge releases a cloud of metal strips into the air. These strips momentarily act as a decoy for *radar-guided* missiles. A *flare* is a container of burning metal such as magnesium — flares serve as decoys for *heat-seeking* missiles.



Fire chaff (counters radar-guided missiles)



Fire flare (counters infrared-guided missiles)

## DETECTING BY RADAR

The F-4 Phantom is equipped with search/track radar for air-to-air interception. The radar control switch is used for both locating enemy aircraft and providing radar reflection for the radar-guided AIM-7 Sparrow missile (see *Firing Missiles* in this chapter).

Since it only carries infrared-guided missiles, the MiG-21 requires only a simple search radar unit.



Radar on/off

The radar's search area is limited to a narrow cone emanating from the nose of your aircraft. You can only detect planes you are facing — you *cannot* detect airplanes behind you (use your RWR for that). Unlike your RWR systems, radar *can* detect infrared missiles.

When you turn on your radar, the radar monitor on the Instrument Panel is illuminated. The small white dot at the bottom of the readout indicates your aircraft. Other dots indicate aircraft or recently launched missiles in your path.

Since Vietnam era radar did not possess IFF (Identify Friend or Foe), the only way to identify an aircraft on your radar screen is to draw close enough to make visual contact.

### QUICKLY LOCATING FRIENDLIES AND ENEMIES

Two keys increase your Situational Awareness by giving you the clock coordinates of the nearest enemy or friendly plane. Some fighter pilots have reported irrationally *sensing* that another plane is in the vicinity — this is the equivalent of that intuitive knowledge.

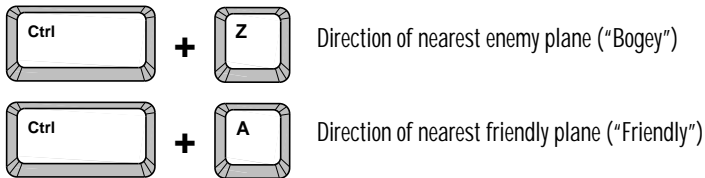

If no bogeys are in the area when you press Ctrl-Z, a message — "Can't find any bogeys" — appears in the Warning/Communications line at the top of the HUD." Likewise, pressing Ctrl-A with no friendlies in the sky gets you a "Can't find any friendlies" message.

### THE CLOCK

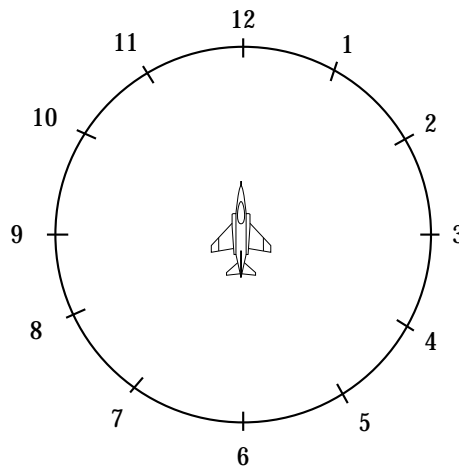

*Ever since radio accompanied pilots into the air, the clock has been used to communicate the general direction of bogeys (unidentified aircraft) relative to the pilot. Imagine your aircraft as the fixed point in the center of a huge clock. The nose of your plane always points to 12. Enemy aircraft are identified as being located at positions on the face of the clock, with relative altitude indicated as low or high. For example, "Bogey at 3 o'clock" would indicate an aircraft to the right; "Bogey at 3 o'clock low" would indicate an aircraft below and to the right.*

## NAVIGATING

Navigating is only a concern when flying Historic Missions. Your mission's success depends on you accomplishing your mission objectives and returning home safely.

You navigate by flying to a designated *waypoint*, changing course, flying to the next waypoint, and so on. Use the waypoint indicator to set your heading toward the current waypoint.

### P-51 AND FW-190 WAYPOINT INDICATORS

The two red dots below your compass are your waypoint indicator. A single red light indicates the direction you should turn to get back on course. Two red lights indicate that you're heading in the right direction.



Red dot here means 'turn right'



Two red dots means you're on course

### F-86 WAYPOINT INDICATOR

The waypoint indicator is on the the compass. The light red needle is the direction you're currently headed. The dark red needle indicates the direction to the next waypoint. To get on course, turn until the light red needle covers the dark red needle, and then level out.



Turn right

### F-4, MIG-21, MIG-15 AND F-86 NAVIGATION COMPUTERS

The gauge marked DIR or NAV indicates the direction to the next waypoint. When the needle is at 12 o'clock (straight up), you're headed in the right direction.



Turn right



Waypoint is directly behind you

### HEADING TO THE NEXT WAYPOINT

The waypoint indicator will not tell you when you've reached a waypoint. To find out the distance to the waypoint, press F9 to bring up the Map.

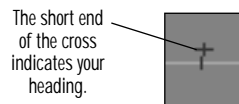
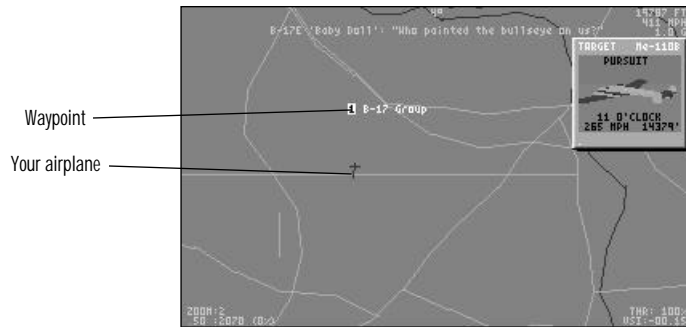

At any time during the mission, you can instruct the waypoint indicator to indicate the direction to a different waypoint.



Direction of the next waypoint



+



Direction of the previous waypoint

## COMMUNICATIONS AND WARNINGS

Radio communications and warning messages appear at the top of the HUD. Communications can be anything from a simple exclamation ("They're taking the bait!") to an enemy location ("Fighters at 3 o'clock"). Messages warning you about dangerous flight conditions ("APPROACHING STALL") also appear at the top.

## DAMAGE

Press D to briefly display a status message at the top of your HUD telling you how much damage your aircraft has sustained as a percentage of the total damage it can withstand. For example, 50% damage means if you take as much damage as you've already absorbed your plane is destined to become part of the landscape.

## EJECTING

If you let the enemy maul your airplane bad enough, you may be forced to hit the silk. It's always better to jump than to follow a lost airplane into the ground.

You can only eject safely at speeds of 500 mph or less — at higher speeds, you risk ripping your head from your shoulders. Your altitude in any jump should be a minimum of three hundred ft.



If you do jump, take advantage of the splendid view. Use the View keys to take a look around.



Remember, the real hero is the one who survives.

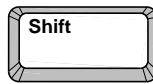

+



Eject.



*Early in my tour, I heard that one of the guys had seen a 109 strafe an American bomber crew in their chutes. I thought it was bad practice in every way. Both sides at least gave lip service to a gentleman's agreement not to do it. And if I had to jump for it again, I could hope the agreement was being honored that day.*

## TIME COMPRESSION

In time compression mode, the game runs at twice or four times normal speed. If you're too far away from your targets, you can use time compression to reduce the time it takes you to get to them. It's also useful for flying back to home base after a successful mission.



Time compression

Press T to let the game run at 2x its normal speed. Press T again for 4x normal speed. To turn off time compression, press T a third time.

Stay awake while flying in time compression mode. Your opponents are twice as fast, too. If you detect enemies while flying in time compressed mode, *turn it off* before you attempt any maneuvers. It's easy to put yourself into an irrecoverable dive or spin if you maneuver in time compression mode.

## BLACKOUTS AND REDOUTS

After a few seconds at positive high g loads, the vessels in your legs and lower extremities expand and the blood begins to drain into your lower body. Your heart loses its ability to pump blood to your brain, and the pilot begins to have problems. Peripheral vision is the first thing to go, followed by forward vision. If the turn is held too long, consciousness itself will fade away and the pilot will typically auger in.

A similar phenomenon occurs when you pull high negative g's, only in this situation the blood rushes to your head and you experience a redout.

To recover from a blackout or redout, ease up on the stick until your vision returns. You can avoid both blackouts and redouts by pressing Ctrl-B.

## CHANGING THE HUD COLOR

You may want your HUD readout to be more or less noticeable. Press Ctrl-R to cycle through the different HUD colors available to you.

## FLIGHT MENUS

The Flight Menus contain options that let you configure the game to your liking. Press Esc at any time during the mission to bring up the Flight Menus.

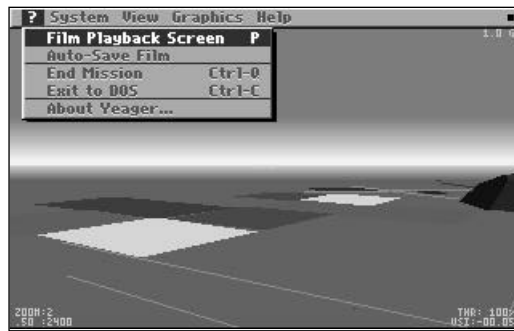

See the options in the previous menu



See the options in the next menu

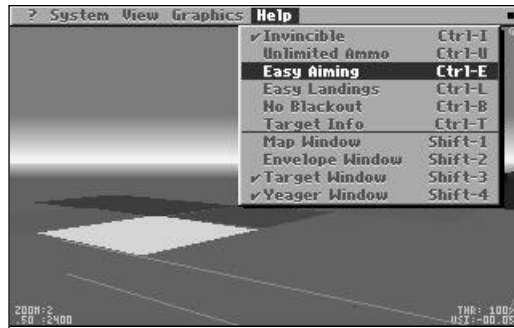

Move the highlighted bar up



Move the highlighted bar down



Go to first option in menu



Go to last option in menu



Go to next group up separated by line



Go to next group separated by line

*Air Combat* automatically configures itself to your graphics adapter sound and control devices, but there are many options you can set yourself. When you quit the game, *Air Combat* saves your current configuration. The next time you start the game, your configuration will be the same as when you quit your last game.

Many of the Flight Menu options are features that can be turned on or off. For example, selecting Map Window from the Help Menu displays the Map Window. A check (✓) appears by any feature that's been activated.

Almost every option has a shortcut key that lets you select the option without opening the Flight Menu. For instance, pressing Ctrl-I while in flight makes you invincible without bothering to find the option in the menus.

#### ? MENU

Film Playback Screen



Brings up the Flight Recorder. See *Flight Recorder* for details.

#### Auto-Save Film

When checked (✓), this option automatically saves the last several minutes of your last mission. With Auto-Save Film active, you don't need to worry about saving a recording before you end the mission. To see your last mission, select Review Film from the Main Menu. If you want to keep the flight recording, select SAVE and rename the film (see *Flight Recorder*).

#### End Mission

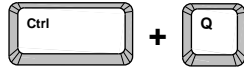

Ends the mission. If you were flying an historic mission, the Mission Debriefing screen appears. If you were flying a custom mission, the Stats screen appears.

#### Exit to DOS

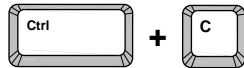

Quits *Air Combat* and returns you to DOS.

#### About Yeager

Brings up the official game credits and copyright date. Press any key to continue.

#### SYSTEM MENU

##### Sound

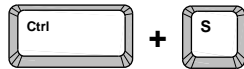

When checked (✓), you'll hear all of the sound effects checked below. This option must be active to hear Background, RWR, and/or Stall Sounds. If Sound is not checked, *no* sound effects are produced.

##### Engine Sounds

When checked (✓), you hear the sound of your engine. (In Target → Plane mode, you'll hear the sound of your *enemy's* engine). The Sound option (above) must be active to hear Engine Sounds.

##### RWR Sounds

When checked (✓), a warning sounds when an enemy has a radar lock on you (a low-pitched beeping sound) or when an inbound radar-guided missile has a target lock on you (a high-pitched beeping sound). The Sound option (above) must be active to hear RWR Sounds.

#### Stall Sounds

When checked (✓), you hear a warning for stalls. The Sound option (above) must be active to hear Stall Sounds.

#### Lock Sounds

When checked (✓), you hear a warning telling you when your missile is locked on the target. The Sound option (above) must be active to hear Lock Sounds.

#### Keyboard

When checked (✓), selects the keyboard as your flight stick and weapon control device.

#### Joystick

When checked (✓), selects the joystick as your flight stick and weapon control device. You can also select this option to calibrate your joystick. Follow the on-screen prompts.

#### Mouse

When checked (✓), selects the mouse as your flight stick and weapon control device.

#### Hi-Res Mouse

When checked (✓), if your mouse seems too sensitive, select Hi-Res Mouse as your control device. With Hi-Res Mouse active, you have to move the mouse farther to get the same effect.

#### 1x Time

When checked (✓), the game runs in normal or "real" time. You can press T to switch from normal time to time compression mode.

#### 2x Time

When checked (✓), game time is compressed so that everything runs at twice the normal speed. You can press T to switch from time compression mode to mega-time compression mode.

#### 4x Time

When checked (✓), game time is compressed so that everything runs at four times the normal speed. You can press T to switch from mega-time compression mode to normal time.

#### VIEW MENU

You can switch views using the view commands or by selecting options from the View Menu. For view commands and descriptions of each of the views, see *View Keys* in this chapter.

#### GRAPHICS MENU

#### Low Detail

When checked (✓), all objects are displayed with minimum detail to increase simulation speed.

**Medium Detail**

When checked (✓), all objects are displayed with medium detail.

**High Detail**

When checked (✓), all objects are displayed with maximum detail.

**Simple Planes**

When checked (✓), you never see the most complex shapes for planes regardless of the detail setting above. This is useful if your machine is slow but you want to keep your display speed fast during combat.

**Dithered Horizon**

When checked (✓), the horizon is dithered to give the illusion of distance. This feature is only available in VGA and MCGA 256-color modes. You can turn off the dithered horizon to increase simulation speed.

**Clouds**

When checked (✓), you may or may not see clouds at varying altitudes. You can turn off the cloud effects to increase simulation speed.

**Bitmap Explosions**

When checked (✓), you see bitmapped explosions when planes blow up. You can turn off the bitmapped effects to increase simulation speed. This feature is not available in CGA mode.

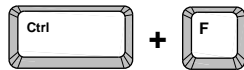
**Flight Info**

When checked (✓), the HUD (Heads Up Display) is displayed on your screen. For details on the HUD, see "Flight Instruments" in *Instrument Check*.

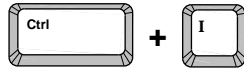
**HELP MENU****Invincible**

When checked (✓), your airplane is invincible to enemy weapons. Note, however, that you can still crash and rip your wings off.

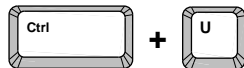
**Unlimited Ammo**

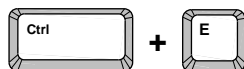

When checked (✓), you have unlimited ammo.



**Easy Aiming**



When checked (✓), you can be a little less accurate aiming because more of your misses will be counted will be counted as hits. This goes for missiles as well as bullets.

Note: If you're using a keyboard or mouse to control the airplane, this feature is not considered a help. Keyboard and mouse users can take the Ace's Challenge with Easy Aiming active (see "Ending the Historic Mission" under "Historic Campaigns" in *Mission Menus*.)

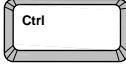



**Easy Landings**  +   
When checked (✓), you cannot crash *no matter how hard you land!*

**No Blackout**  +   
When checked (✓), you can pull any number of g's without experiencing blackouts or redouts.

**Target Info**  +   
When checked (✓), target information is displayed below each target. The color of the target info indicates your opponent's awareness of your location — red means he's located you, black means he hasn't. The percentage indicates your *average* chance of hitting the target at this range with the currently selected weapon.



At this range, this F-86 pilot has about a 84% chance of hitting the MiG-15 with his .50 caliber guns.

**Map Window**  +   
When checked (✓), the Map Window is displayed on your screen. The Map Window provides you with the location of all friendly and hostile aircraft in the area.



You can magnify the range of the Map Window by pressing period (.). At full magnification, fighters appear as a single pixel (one dot) and bombers as two (two dots). To decrease the range of the Map Window, press comma (,).

#### Map Identification Key for EGA, VGA, MCGA

White	Your airplane
Dk. Red	Bogey below
Lt. Red	Bogey above
Dk. Blue	Friendly below
Lt. Blue	Friendly above
Yellow	Missile (with target lock)
Grey	Missile (no target lock)

## Map Identification Key for CGA

Lt. Cyan	Friendly
Lt. Cyan	Bogey
White	Locked missile
Lt. Magenta	Unlocked missile

## Envelope Window

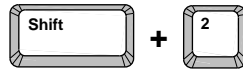

When checked (✓), the Envelope Window is displayed on your screen. For details on the Envelope Window, see *Ground School*.

## Target Window

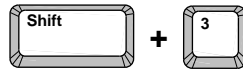

When checked (✓), the Target Window is displayed on your screen. The Target Window provides you with useful information about the currently selected target.

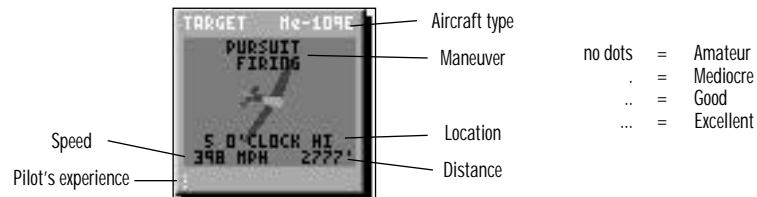

For hints on getting the most out of the Target Window, see "Detection" in *Fighter Tactics*.

## Yeager Window

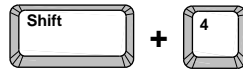

When checked (✓), the Yeager Window is displayed on your screen. Yeager watches your six, tells you how to correct dangerous flight performance problems, and gives you tips on flying and fighting.







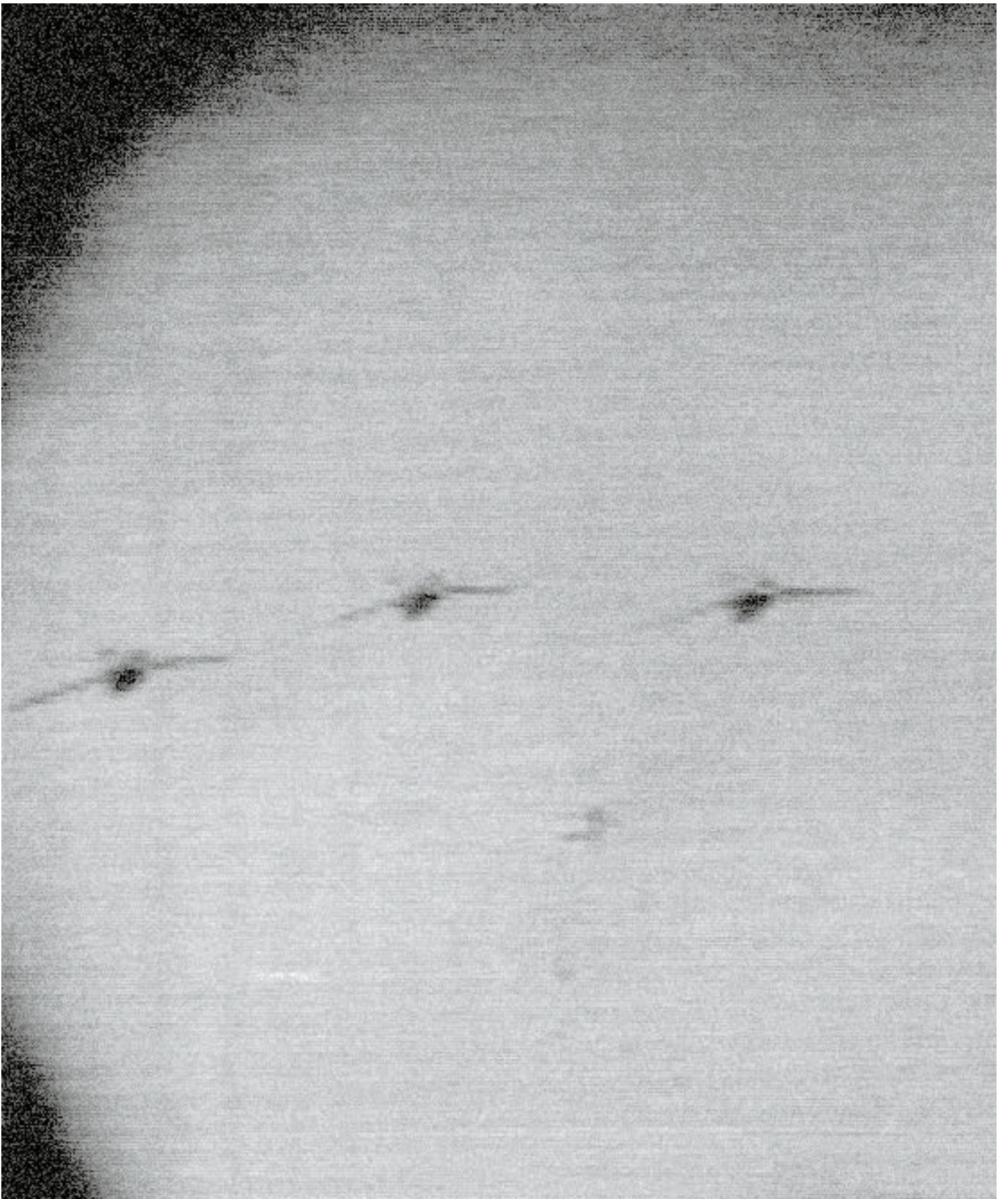



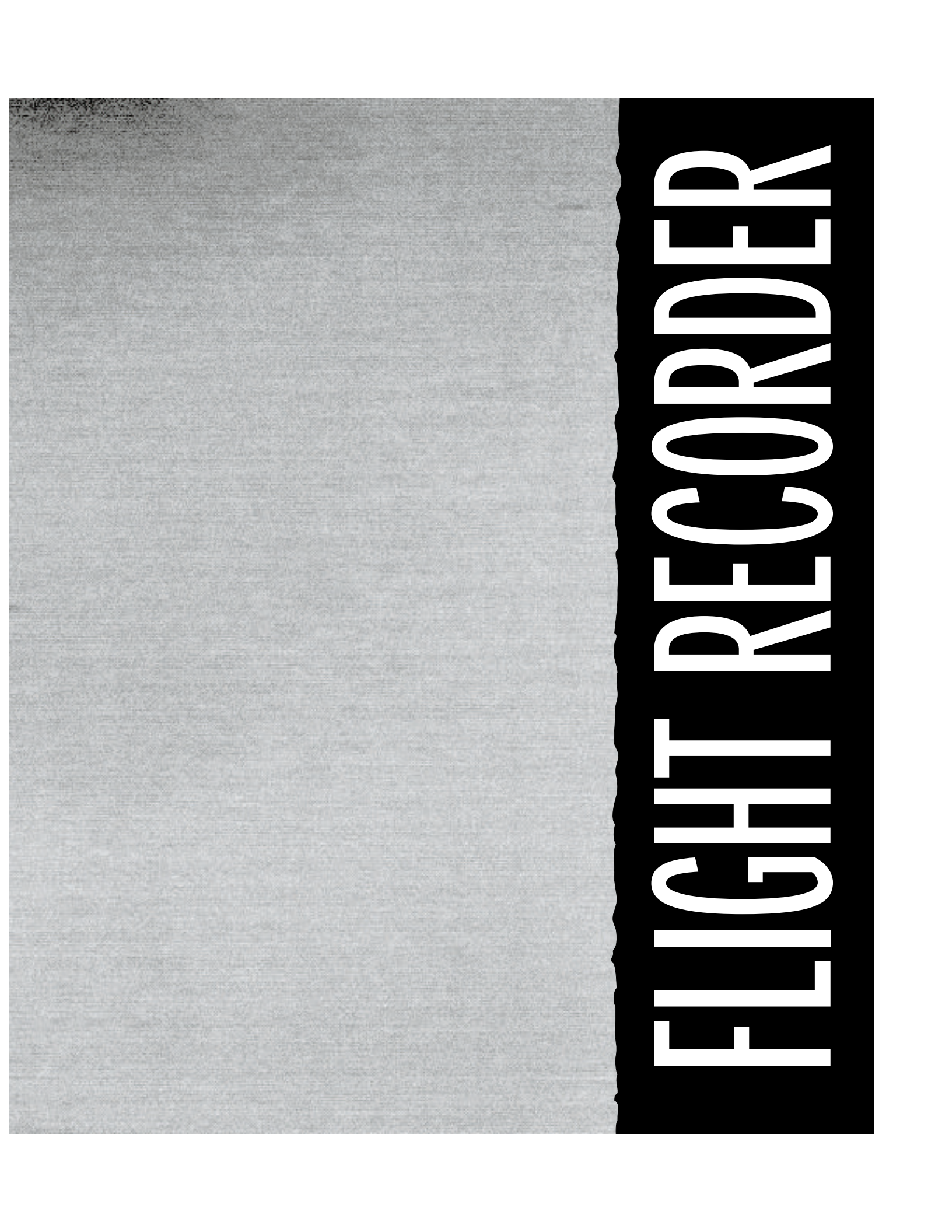

# FLIGHT RECORDER



## FLIGHT RECORDER

The Flight Recorder lets you review and/or save your progress in a current mission as well as load any previously saved flight recordings. VCR style controls let you rewind, fast forward, or watch events frame by frame, while *Air Combat's* standard view keys let you watch your best dogfights from an infinite number of viewpoints. You can also use the unique Box View to see a large-scale overview of any mission.

### PLAYING BACK YOUR CURRENT MISSION

To review the last several minutes of the mission you're currently flying, press P (or press Esc to bring up the Flight Menu, and then select Film Playback Screen from the ? Menu). When you press P, you can only play back the mission you're currently flying — you cannot load previously saved flight recordings.



#### Time Counter

Shows current position in the flight recording.

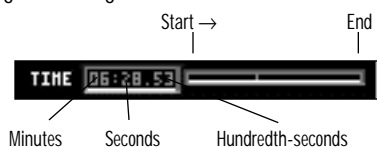

#### Playing Speed Controls

Use the Playing Speed Controls to adjust how fast you play the flight recording.

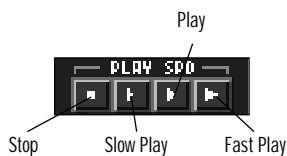

#### Position Controls

Use the Position Controls to "skip" to different parts of the flight recording.

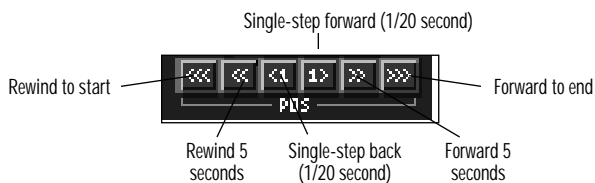

### View Mode Indicator

The view mode indicator tells you which view you're currently watching from. See "View Commands" in *In the Cockpit* for more on views.

### Next Target

You must be in a target view to use the Next Target option:

F7	Plane → Target
F8	Target → Plane
Shift-F7	Target's Cockpit
Shift-F8	External Target

When you're in a target view, select Next Target to cycle through the targets in the mission, regardless of whether they are currently within sight of your airplane. You can also press F7, Shift-F7, F8, or Shift-F8 repeatedly to cycle through the targets.

### Zoom Controls

Use the Zoom Controls to zoom in and out on the action. From the default zoom setting of 1, you can zoom in to 2, 4, 8, 16, or 32.

### I/O Controls

Use the I/O Controls to save a flight, load a previously saved flight recording, or exit the Flight Recorder. See *Saving a Flight Recording* and *Reviewing a Previously Saved Flight Recording* in this chapter.

### ROTATING THE CAMERA

In any view, you can rotate the camera angle 360° vertically and horizontally.

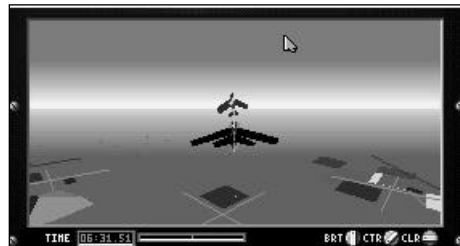

### Mouse Users

To rotate the camera, move the mouse cursor to one of the defined quadrants.

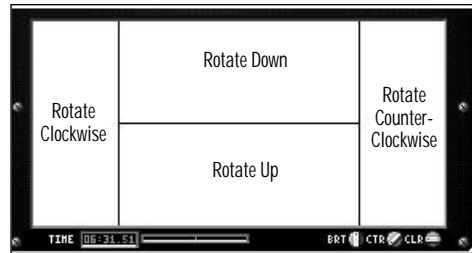

Click a mouse button to nudge the camera, or hold down the mouse button to rotate more quickly.

#### Keyboard Users

Press Ctrl with the cursor arrow keys to rotate the camera.

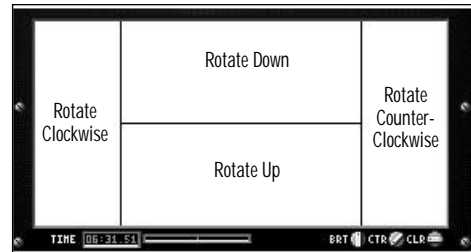
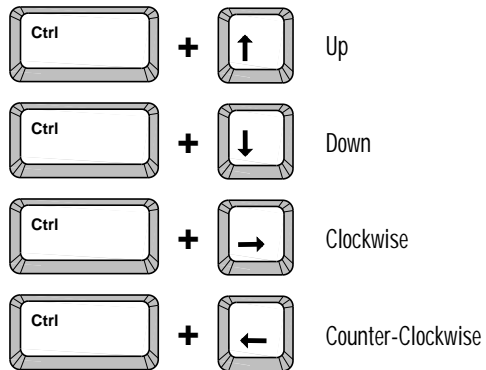

Alternatively, press Tab repeatedly until the cursor lands on a rotation hotspot, and then press the spacebar to rotate your view.

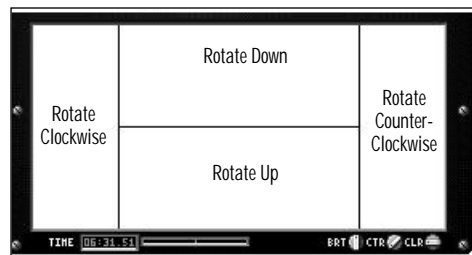

#### SWITCHING VIEWS

All of the View keys function in the Flight Recorder except the Map View (F9), which is replaced by the Box View.

### Box View

The Box View gives you a large-scale, 3D view of the recording. Press F9 to switch to the Box View. Press any other View key to switch back to normal viewing.



### Identification Key for Box View

White	Your airplane
Yellow	Bullets or missiles
Lt. Magenta	Explosions
Lt. Blue	Friendlies and bailed out pilots
Red	Hostiles
Dk. Grey	Shadow if bottom of box is at ground level
Dk. Blue	Shadow if bottom of box is above ground level

You can rotate the box by clicking in the box or using the rotation keys (see “Rotating the Camera” in this chapter).

### Viewpoints in the Box

The standard viewpoint in Box View is from a fixed point, the airplanes weaving through the 3D space of the box. However, there are two options that allow you to slightly alter the standard viewpoint. You can activate one or both of these options:

**Heading** — Press H to have your view follow your fighter’s *heading*. The box rotates horizontally as your airplane travels through the air. Imagine a camera following your airplane.

**Position** — Press P to keep your airplane in the center of the box.

### Zoom Keys

Use the zoom keys (+, -) to increase or decrease magnification of your view.

## SAVING A FLIGHT RECORDING

While you’re flying, *Air Combat* temporarily records the last several minutes of the mission. The length of this recording varies depending on your computer and the number of aircraft in the mission, but on the average *Air Combat* will record the last four to six minutes of the mission. If you’re flying a long mission, you may want to save segments of it so you don’t lose them. For example, if you’ve flown for four minutes and you’re still not done with the mission, you should save a segment; after eight minutes you should save again; etc.

### SAVING A FLIGHT RECORDING WHILE FLYING

To save a flight that's in progress, press P to bring up the Flight Recorder. Select SAVE from the I/O Controls. You'll be asked to name the recording:



Type a name for the flight recording (up to 8 characters) and press Enter. The flight recording is saved in the game directory as a file with the extension ".F". For example, if you named the file "AWESOME," it would appear in the game directory as "AWESOME.F". When you're ready to continue the mission, press Esc or select EXIT from the I/O Controls.

You can save as many segments of the mission as you like, but you can only watch the last several minutes played. To review earlier segments that you've saved, select Review Film from the Main Menu (see *Reviewing a Previously Saved Flight Recording* below).

### THE AUTO-SAVE FILM FEATURE

When active, the Auto-Save Film feature automatically saves the last several minutes of your mission as a flight recording. With Auto-Save Film active, you don't need to worry about saving a recording before you end the mission.

To activate Auto-Save Film:

1. Begin any mission.
2. Press Esc to bring up the Flight menus.
3. Select Auto-Save Film from the ? Menu. A check (✓) should appear beside the Auto-Save option.

When you end the mission, the last several minutes of the mission are temporarily saved as a flight recording named LAST.

To watch LAST, select Review Film *before you engage in any other missions*. When the LOAD FILE box appears, select the arrows to scroll through the missions you've recorded. When LAST appears, select it. Use the Playing Speed Controls and the Position Controls to review the film.

If you want to save the new flight recording, select SAVE from the I/O Controls. You'll be asked to name the recording. You *must* rename LAST if you want to keep it — if you don't, LAST will be overwritten the next time you fly a mission. Type a new name for LAST (up to 8 characters) and press Enter.

### REVIEWING A PREVIOUSLY SAVED FLIGHT RECORDING

To load a previously saved flight recording, select Review Film from the Main Menu.

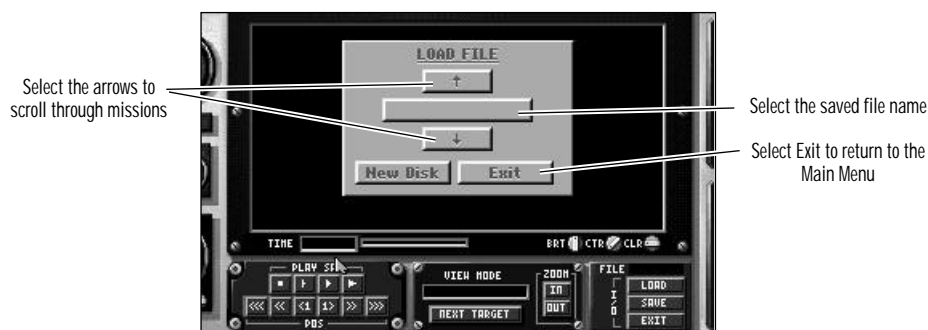



When the LOAD FILE box appears, select the arrows to scroll through the missions you've recorded. When the name of the file you want to watch appears, select it. Use the Playing Speed Controls and the Position Controls to review the film.

#### NEW DISK

For floppy users only. If you're looking for a certain flight recording and it's not on the disk currently in the drive, remove the disk and insert another. Select New Disk to see the flight recording files on the current disk.

#### DELETING FLIGHT RECORDINGS

Each flight recording is saved as a separate file in the game directory — any file with a ".F" extension is a flight recording. You can only delete flight recordings by exiting to DOS. Refer to your DOS manual for information on deleting files.





# GROUND SCHOOL

## GROUND SCHOOL

*Air Combat* models the real flight envelopes of eighteen different aircraft. Each aircraft performs differently according to its airspeed, altitude, and structural limits. These factors affect everything from maneuverability — how quickly an airplane can turn — to minimum and maximum speeds.

The basic aerodynamics explained here have very real applications in *Air Combat*. Knowing — not guessing — how your airplane performs can mean the difference between painting a flag on your fuselage or drilling a 50 ft. hole in Mother Earth.

### AIRPLANE MOVEMENT

The pilot controls the airplane by moving a flight stick and pedals in the cockpit. These in turn move *control surfaces* on the wings and tail, causing the airplane to change direction. An airplane can rotate in three dimensions while in flight: it can roll, pitch, or yaw.

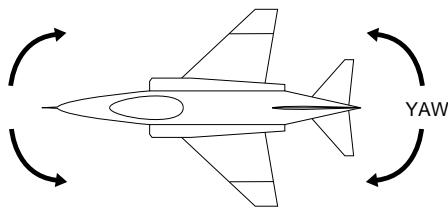
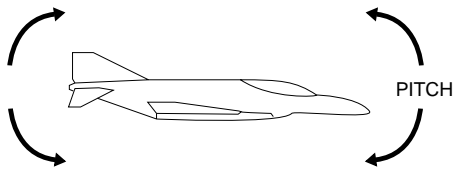
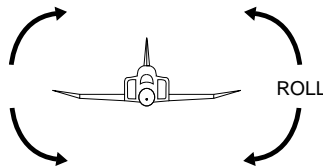

## PARTS OF AN AIRPLANE

### AILERONS CONTROL ROLL

To turn an airplane, you must bank the wings by moving the flight stick left or right. For example, moving the flight stick to the right raises the right aileron and lowers the left, which in turn rolls the airplane to the right.

### ELEVATORS CONTROL PITCH

Pulling back on the flight stick raises the elevators, causing the airplane to pitch up (climb). Pushing forward on the flight stick lowers the elevators, making the airplane pitch down (dive).

### RUDDER CONTROLS YAW

The rudder works in conjunction with the ailerons to coordinate turns.

### FLAPS INCREASE LIFT AND DRAG

Flaps increase wing surface and curvature, thus increasing both lift and drag. They're useful for landing, since they lower your stall speed.

### AIR BRAKES INCREASE DRAG

Air brakes increase drag, thus slowing down the airplane. Prop-driven airplanes don't have air brakes.

### LANDING GEAR

Landing gear is necessary for landing and ground maneuvering. All of the airplanes you fly in *Air Combat* have retractable landing gear.

## ALTITUDE, AIR PRESSURE, OXYGEN

Your airplane doesn't move through a vacuum but rather through a varied environment — the earth's atmosphere. The dynamic of flight is nothing more than an interaction between the atmosphere and your airplane. Fortunately, all that you really need to know for a basic understanding of aerodynamics is this — the higher the altitude, the lower the *air pressure*, *temperature*, and *oxygen content*.



## FOUR FORCES

Four basic forces influence the airplane in flight: lift, weight, thrust, and drag. These are actually forces and *counter-forces*. Lift pushes the airplane up while weight pulls it toward the earth. Similarly, thrust pushes the airplane forward while drag slows it down.

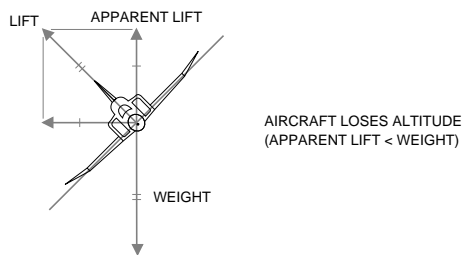

When an airplane is flying *level* (neither climbing or diving), lift and weight are exactly opposed or *balanced*. In the same way, a *constant speed* means that thrust equals drag.

### LIFT VS. WEIGHT

As the jet engines or propellers move the airplane, air rushes over the wings. Since the wing is unevenly shaped — flat on the bottom, arched on the top — the air does not move at a constant speed over both surfaces. The air moves faster over the arch.

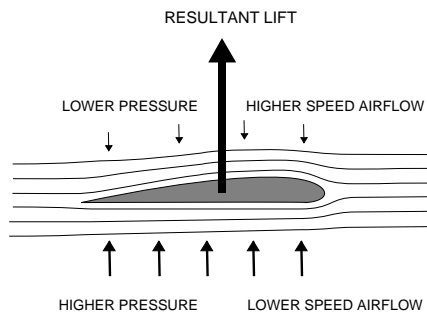

The air traveling over the top of the wing must go a greater distance to get to the trailing edge. It must go *faster* in order to get there.

In fluid dynamics, the law is: The faster a gas or liquid moves, the less pressure it exerts. Since the air, as we know, is moving faster over the arched top, there's less pressure there than on the underside of the wing. This inequality between pressure states is what creates *lift*.

Like any heavier-than-air object, an airplane's natural inclination is to fall to the earth. The force of gravity pulling on the object is what's known as the airplane's *weight*.

**ANGLE OF ATTACK**

The *angle of attack* is the angle at which the wing meets the airflow. An increased angle of attack creates more pressure and therefore more lift. This is how you climb — pulling back on the stick pulls up the nose, which increases the angle of attack and creates lift.

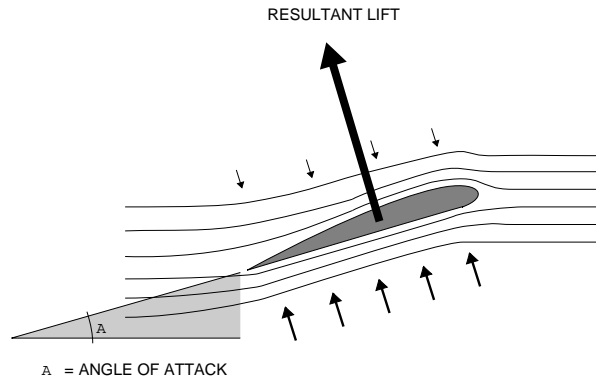

Increased angle of attack creates more lift.

Everything has a cost. As you increase your angle of attack, the increased lift and large surface area meeting the airflow create more drag. This has the effect of slowing down the airplane.

**THRUST VS. DRAG**

Both a spinning propellor and a jet engine spitting superheated gases create *thrust*. In order for the airplane to move forward, its thrust must be greater than the *drag* created by air molecules striking the airplane's surface.

**MAXIMUM SPEED**

As the airplane climbs to higher, oxygen-poor altitudes, thrust decreases. At the same time, however, drag is reduced in the thinning atmosphere. Thus each airplane has an altitude at which the best thrust/drag ratio is achieved — typically at low altitudes for prop airplanes and high altitudes for jet fighters.

**MINIMUM SPEED AND WING LOADING**

As stated earlier, air pressure progressively decreases the higher you fly. To overcome the loss of air pressure, an airplane must go faster to maintain flight (to get the same amount of air flowing over the wings as at lower speeds at lower altitudes).

Minimum speed is a function of the shape of the wing and *wing loading*. Wing loading is the amount of weight the wing surfaces must carry. The more weight the wing carries, the faster the airplane must travel to produce enough lift for level flight. High wing loading is better if you want to go faster; low wing loading is better if you want to turn harder. Additionally, airplanes with long, thin wings tend to perform better at high altitudes than airplanes with short, stubby wings.

### THREE MEASURES OF TURN

#### G FORCE

A “g” is a unit that measures acceleration. This is often used as a measure of centrifugal force. One g is equal to the force of gravity exerted on a stationary object on earth — the force a person standing on the ground experiences.

#### WHY YOU PULL UP THE NOSE IN A TURN

To remain in level flight, the lift vector (arrow) must equal the weight vector.

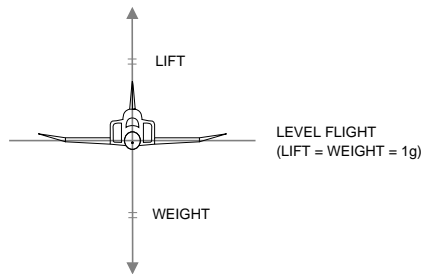

When an airplane rolls over to turn, lift is diminished. Why? The lift created by the wings remains perpendicular to the wingplane. Remember, it's the wingplane that creates the lift. At the same time, however, the weight of the airplane remains pointed to the ground — after all, it's the earth that's pulling the aircraft down. Only the vertical component of the lift compensates for the weight of the airplane — the horizontal component makes the airplane turn. As the airplane banks, the lift vector tilts, decreasing its vertical component and increasing its horizontal component while the total (resultant) lift remains the same.

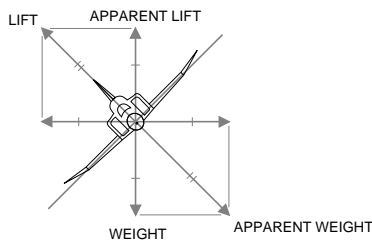

To generate more lift to overcome the airplane's weight, the pilot pulls back on the flight stick — a process called “trimming” — thereby increasing the angle of attack and creating more lift to increase the vertical component enough to counteract the airplane's weight. At the same time, more lift creates more drag, slowing down the airplane. This is why maneuvering in combat is an energy-depleting activity.

#### THE EFFECTS OF G IN THE COCKPIT

Every vector has a *counter*-vector. When lift is increased in a turn, its counter-vector is the *apparent weight* of the airplane — the pilot in the airplane feels heavier, what is called *apparent weight* or *g-load*. This is the same force at work when you're pinned to your seat in the tight turn of a roller-coaster.

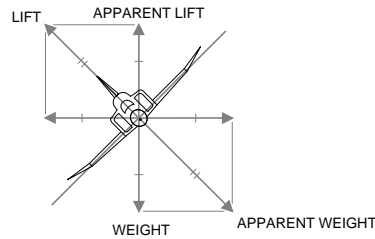

The more the airplane banks, the greater the g load experienced by the airplane.

#### TURN RADIUS — HOW WIDE YOUR TURN IS

Simply put, *turn radius* is how big of a circle you make in the sky. The size of the circle depends on how fast you're flying and how tightly you're turning. A jet can turn more tightly than a prop airplane but still make a wider circle by virtue of its higher speed.

#### RATE OF TURN — HOW QUICKLY YOU'RE TURNING

Rate of turn tells you how quickly you're turning. To put it simply, rate of turn is how fast you can haul your nose (and weapons) around to put the enemy in your gun sights. The higher your speed at a given altitude, the lower your maximum rate of turn.

The importance of your rate of turn in air combat can't be understated. You need a good rate of turn for both offensive and defensive purposes — to turn sharply enough to get the enemy into your sights, or to stay ahead of *his*.

#### MAXIMUM RATE OF TURN

If you're breaking with an opponent and he remains ahead of your gun sights, you must somehow turn more tightly so you can shoot him down. In a turning contest such as this, your rate of turn compared to your opponent's becomes crucial. Does your airplane turn faster than his? Rather than finding out by waiting for his bullets to tear up your airplane, you can compare flight envelopes.

### THE FLIGHT ENVELOPE

A flight envelope is a graph that shows the interaction of an airplane with its environment and the limits of its performance. Below is the flight envelope for the F-4 Phantom.

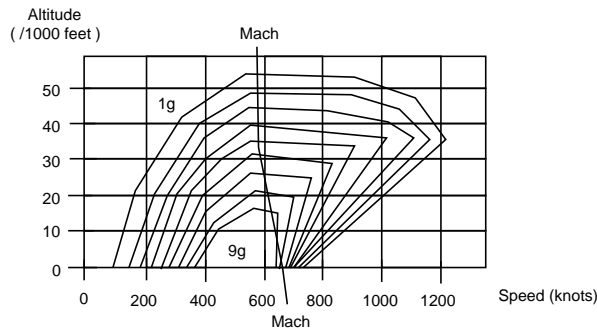

On the vertical axis of the graph is the airplane's altitude; on the horizontal axis is the airplane's speed. Plotted on the graph are curved lines. The outside line contains the airplane's performance at 1 g (level flight). Within that boundary are curves which contain the airplane's performance at higher g's (banking or climbing).

**Lift limit** — The limit beyond which the airplane stalls due to a lack of lift.

**Thrust limit** — The limit beyond which the engines can't generate enough thrust to accelerate.

**Structural limit** — The limit beyond which the airframe can't withstand the air resisting it. Continuing beyond this limit will weaken the airframe and eventually rip your wings off.

What follows are some examples of how to read flight envelopes.

#### THE F-4'S MINIMUM SPEED

The flight envelope contains all the information on an airplane's performance. The left edge of the 1 g envelope shows that the airplane's minimum speed increases with altitude. The higher you go, the faster the F-4 needs to go in order to generate lift. This is related to the steadily decreasing air pressure of the atmosphere — the less air, the less lift.

Speed increase up to ~37,000 ft  
Maximum speed of 1,386 mph  
The higher you go, the fewer g's you can hold.  
Minimum speed increases with altitude.  
Lack of oxygen reduces thrust in the upper atmosphere.  
The airplane's ceiling  
Minimum and maximum speeds are reduced by the need to maneuver.

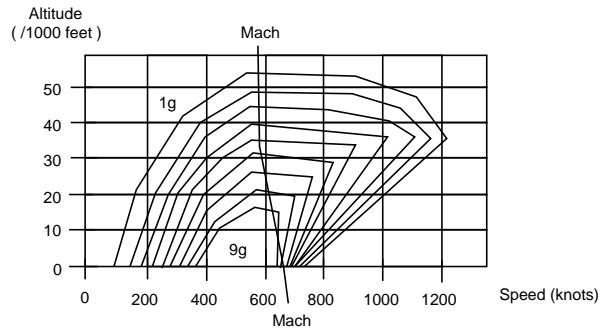

#### THE F-4'S MAXIMUM SPEED

The right edge of the envelope shows the F-4's top speed of 1,386 mph. Notice that this speed only occurs around 38,000 ft. This is the altitude at which the engines produce the maximum thrust against the minimum drag. This number has an obvious application: if you need to get somewhere fast, climb to the altitude where your maximum speed is greatest.

#### SPEED DIMINISHES ABOVE AND BELOW 38,000 FT

Below 38,000, the airplane's top speed falls. The air in the lower regions of the atmosphere is too thick for the airframe — it would actually disintegrate if it went any faster. Above 38,000 ft, thrust begins to give out. As the air thins out in the upper atmosphere, there's less oxygen to burn fuel and create lift. Notice that the maximum speed decreases as the airplane climbs higher, eventually reaching an altitude where the airplane can't fly at all. This absolute height limit is known as the airplane's *ceiling*.

#### THE INNER ENVELOPES

The inner envelopes show the minimum and maximum speed of the F-4 while turning. For example, an F-4 at 10,000 feet in a 9 g turn must be travelling at least 500 mph and no more than 710 mph in order to maintain the 9 g's. Notice, too, that it's not even *capable* of doing a 9 g turn at altitudes greater than 16,000 ft!



As stated before, you want the best rate of turn possible if you're trying to out-turn and outmaneuver your opponent. Your best rate of turn is achieved by pulling as many g's as you can at your current altitude, but at the lowest speed necessary for that number of g's. For example, if you're flying the F-4 at sea level, your maximum rate of turn will be the lowest speed in the 9 g envelope.

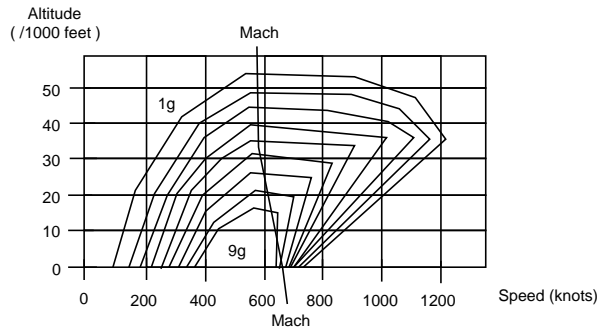

Achieving the maximum rate of turn for an F-4 Phantom at sea level is accomplished by pulling a 9 g turn at the lowest speed possible: 425 mph.



*At high altitudes, be gentle on the stick or you'll lose valuable airspeed from a high angle of attack and you'll eventually stall, which will cost you altitude.*

#### USING THE ENVELOPE WINDOW

You can use the Flight Envelope Window to foresee potential flight performance problems and — in the event that you've flown to the limit of your airplane's ability — you can use the information to take the right corrective measures. To display the flight envelope of your fighter, press Shift-2.



Increase throttle to 100% and point the nose down  
Decrease speed or reduce altitude  
Slow down! Flaps down, air brakes if possible, even landing gear!

#### FLIGHT PERFORMANCE RECOVERY

##### HOW NOT TO EXCEED MAXIMUM SPEED

The airplane's maximum speed is also limited by the strength of its airframe. A sustained dive at 100% throttle can very well rip your wings off. If you know that you're exceeding maximum speed, cut the throttle, put down flaps and air brakes, and pull back on the stick.

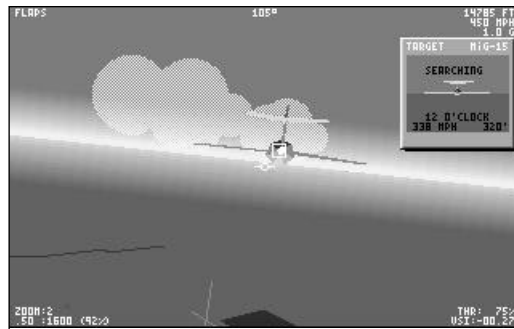

### STALLS AND HOW TO RECOVER

If the angle of attack is increased too much, the low pressure area degenerates quickly and a stall occurs. The airplane will lurch suddenly into a dive. You recover from a stall by increasing speed and repositioning the wings such that a smooth airflow over them is regained. When the stall warning appears, set the throttle at 100% and push the flight stick forward.

It's important that you act quickly. A stall at low altitudes can be fatal, because you won't have the room to put your nose down. Take the stall warning seriously!

### USE FLAPS TO POSTPONE A STALL — DANGEROUS MANEUVER

If you're about to enter a stall but you need to postpone it a few seconds (say you're trying to keep your nose up long enough to finish someone off), dropping your flaps will buy you a little extra time.

When your flaps are down, your stall speed decreases due to extra wing surface. However, this is a two-edged sword. Your speed bleeds off *much* faster with flaps down — when you finally stall, your extreme low speed will put you in even deeper trouble if you haven't finished off your opponent.

### USING A STALL TO DIVE — DANGEROUS MANEUVER

If you're near stall speed, your nose is pointed up, and you need to dive quickly, entering a stall will give you an additional downward turning motion over what you could do with the stick alone.

## THE ENERGY STATE

In air combat studies, an airplane's potential to perform at any given moment is often measured as its *energy state*, which is a function of its *potential* and *kinetic* energy.

Potential energy is a function of an object's position within a gravitational field. To use a classic example, the boulder at the top of the hill has greater potential energy than the boulder at the bottom. Likewise, an airplane at a higher altitude has a greater potential energy reserve than the one flying 10,000 feet below it. If the airplane goes into a dive, it converts its potential energy (altitude) into kinetic energy (velocity). The airplane didn't get this energy for free. It "bought" this energy by climbing to the higher altitude in the first place (that is, burning fuel).

Kinetic energy is a function of from an object's momentum. If two airplanes are flying at equal speeds, the heavier of the two has more kinetic energy (because it has more momentum). The heavier airplane "bought" this energy when it accelerated to the speed of the lighter airplane. (The lighter airplane invested less energy getting to the same speed.)

Potential and kinetic energy can be exchanged, by climbing and diving. Climbing converts kinetic energy into potential energy (as you gain altitude you lose velocity), while diving converts potential energy into kinetic energy.





# FLIGHT SCHOOL



## FLIGHT SCHOOL



*The sky was filled with green pilots practicing landings, dogfighting, and strafing, so accidents were inevitable...Guys snapped wings off their planes doing crazy power dives, or buzzed into the side of a hill. And if something went wrong, they made the wrong decision about whether to jump or stay. I saw a guy try to land with his engine on fire, flames streaming, doing at least 150 mph, skidding off the runway in flames and smoke. The crazy bastard hit the ground on the run just as his tail melted off.*

You begin training with a few simple maneuvers that every pilot must know. Take Off and Landing are necessary for getting on and off the ground, while Level Flight, Climb, Dive, and Break are the fundamentals of almost every other combat maneuver you will learn.

### LEVEL FLIGHT

Level Flight is flying with your wings parallel to the ground, neither gaining nor losing altitude.

Generally speaking, when the waterline marker on your HUD is even with the horizon, you're in Level Flight.

However, when landing, the waterline can be above the horizon while you're still maintaining your present altitude — this is due to the increased angle of attack as you approach the runway.

### CLIMB

A climb is a sacrifice of speed for altitude.

#### CLIMBING

1. Increase power to 100% and pull back on the flight stick.  
Watch your vertical speed indicator (VSI). Prop-driven airplanes can climb steadily at about 2000 ft/min, jets much faster. Keep an eye on your airspeed — if you're close to stalling, don't climb so fast. A good rule of thumb is to maintain 180-200 mph during the climb.
2. When you reach the desired altitude, push the flight stick forward to level out, and then return the flight stick to center.

### DIVE

A dive is a sacrifice of altitude for speed.

#### DIVING

1. Push forward on the flight stick to initiate the dive, and then return the flight stick to center.  
The length of time you hold the flight stick forward determines how steeply you dive. If the dive is very steep, you may have to cut power and/or drop flaps or air brakes in order to avoid going too fast.
2. As you reach the desired altitude, pull back on the flight stick to level out. Return the flight stick to center.

#### EMERGENCY PROCEDURES (POWER DIVE)

Exceeding maximum speed in a dive — known as a power dive — can rip your wings off if you don't pull out of it. If you find yourself in this unlucky situation, cut the throttle (if it's not already) and pull back on the flight stick. If you're still accelerating too quickly, try applying air brakes (if you're in a jet), lowering flaps, or — as a last ditch maneuver — lowering your landing gear to create drag.

**BREAK**

A Break is a hard defensive turn to the left or the right. It's immediate purpose is survival — to get you out of your attacker's gun sights. It's secondary purpose is to make a closely pursuing attacker overshoot, thus putting you in *his* six o'clock.

**BREAKING**

1. Increase power to 100% and move the flight stick right or left.  
You want to turn such that you roll the airplane *across* the attacker's path.
2. When your wings are at a 90° angle to the ground, center the flight stick and pull back hard.  
Whenever you go into a steep turn, you lose vertical lift. If you want to maintain your altitude, move the flight stick in the opposite direction.
3. Continue the turn until your opponent overshoots, or try a different maneuver.

**ALWAYS ROLL ACROSS THE ATTACKER'S PATH**

With an enemy on your tail, the instinctive response is to move away from his path. This is exactly what you shouldn't do. The correct response is to roll *across* the attacker's path. You will pass in front of your opponent's guns, but only for a short time — your deflection angle will be so high that it's unlikely that he'll hit you. Breaking across your opponent's path quickly creates "angle-off" (see *Attack* for a description of angle-off).

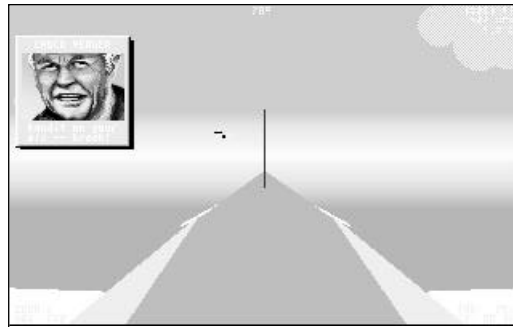

In this situation, you would break left.

**COUNTERING THE DEFENDER'S BREAK**

When your target breaks, it's best to break with the target and stay on his tail.

If your rate of turn is equal to or better than your target's, it's relatively easy to keep him in sight. However, if his rate of turn is better, you can maneuver with a High or Low Yo-Yo (Banked Versions), Barrel Roll Attack, or Scissors (see *Basic Maneuvers*). This reduces your forward velocity and keeps you from overshooting your opponent.

The danger in performing any of these maneuvers is that your opponent slips out of your sight for a moment — and a moment is all it takes for him to give you the slip. Another tactic is to reduce your speed just enough to pull behind him — either by dropping flaps or using your air brakes. Note, however, that you only want to reduce speed when you're:

- At or near your own maximum speed
- In a high thrust/weight plane like the F-4 or MiG-21, in which it's easier to get your speed back.
- Real sure of yourself and your situation.

## TAKE OFF

To take off, your airplane must accelerate from a standstill to an airspeed that generates enough lift to overcome gravity.

### Taking Off

1. Increase power to 100%.

Your airplane begins to accelerate down the runway. *Air Combat's* prop-driven airplanes are all equipped with tail wheels — the nose will drop as the airplane picks up speed.

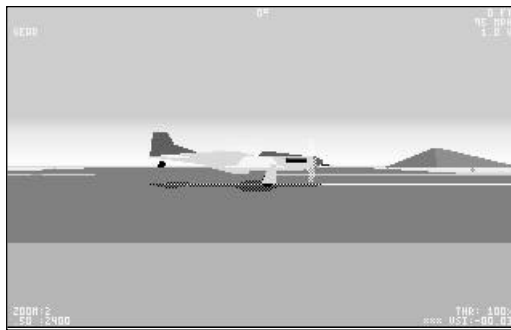

The airplane must reach take off speed before you can pull it up. Take off speeds are:

Prop-driven airplanes	95-100 mph
Korean era jets	135-145 mph
Vietnam era jets	140-150 mph

2. When you reach take off speed, pull the flight stick back until your vertical speed is about 1500 ft/min. Return the flight stick to center. Your vertical speed is displayed in the lower right corner of the HUD or on the vertical speed indicator on the Instrument Panel.
3. Press G to retract your landing gear.
4. Wait for your speed to pick up before you increase your VSI.

Warning! Don't pull the nose into too sharp of a climb or your airplane will stall! At low altitudes, where you don't have hundreds of feet to recover, a stall is lethal.

## LANDING

When landing, your airplane must be traveling close to its minimum speed while still maintaining enough lift (avoiding a stall). On short military runways, you'll need to use flaps to come in at a steep angle of descent.

### LANDING

1. Line up with the runway. Optimally, you want to be about 1000 feet up and five miles out.

The runway should appear about this big in your glareshield:

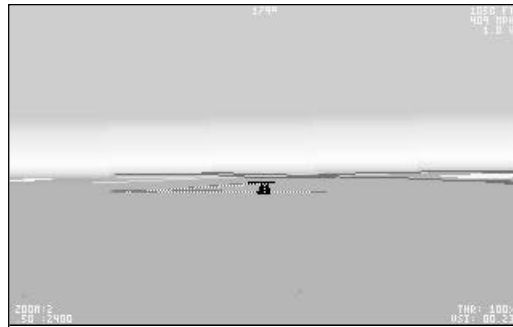

2. Press F to lower flaps and G to lower your landing gear.
3. Aim the waterline marker on the spot on the runway where you want to touch down.
4. Reduce the throttle until you are at your normal stall speed.  
With your flaps down, you won't stall at normal stall speed. If you need a visual guide, use the Envelope Window.



When the airplane borders on the lift limit, you're at the right speed.

5. If you're still going too fast, use air brakes to reduce speed (Korean and Vietnam era airplanes only).  
As you cross the end of the runway, you should be about 100 ft up.

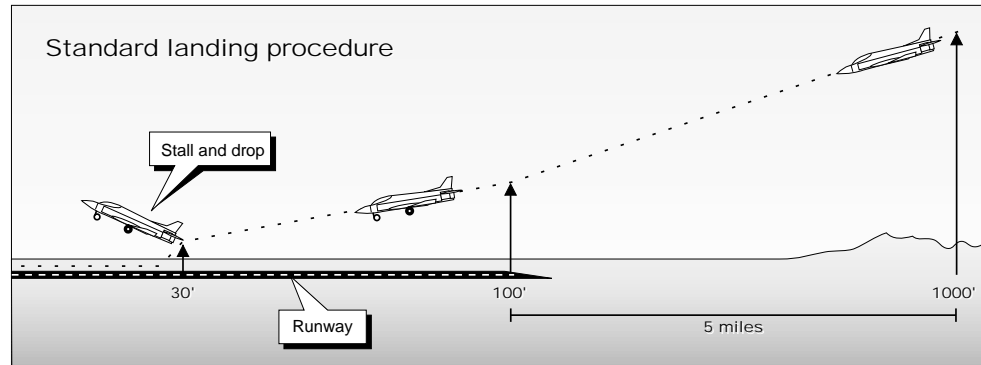

Note: When you've lowered your gear and your flaps and reduced your air speed enough to land, the symbol "xxx" appears next to your vertical speed indicator, at which time it is safe to touch down.

6. Cut the throttle and pull back gently on the flight stick.  
The object is to stall just as you touch down. Watch your VSI and make sure you're still descending (your vertical speed should remain a negative number).
7. As soon as you touch down, apply your wheel brakes.









# BASIC MANEUVERS

## BASIC MANEUVERS



*For every action, there was a possible reaction, and with experience I learned to anticipate and outguess my opponent. I knew, for example, even while I was cutting him off that he would probably try to reverse himself, so I led him a little; if I was right, I had him. If I was wrong, I had to go back to work to get him.*

Experience tells you what is an appropriate move and what isn't. The top aces know when a maneuver puts them at high risk and when the risks of a particular maneuver are acceptable. At the same time, they are aware of the moves available to their opponent and, even while they are maneuvering, are formulating possible counter-maneuvers.

Every fighter pilot must learn and practice the basic maneuvers and their counters. They do not insure the pilot that he will become a top-scorer — that takes something more — but without them, he'll be a sitting duck.

## JINK

"Jinking" is randomly banking and bobbing. It's a purely defensive maneuver designed to upset your opponent's aim while you look for an opportunity to steer into a more advantageous position.

Jinking is effective only against opponents who are within close range. If your opponent is at long range, your jinking will only produce slight movements out of his gun sights — movements that he will find easy to compensate for.

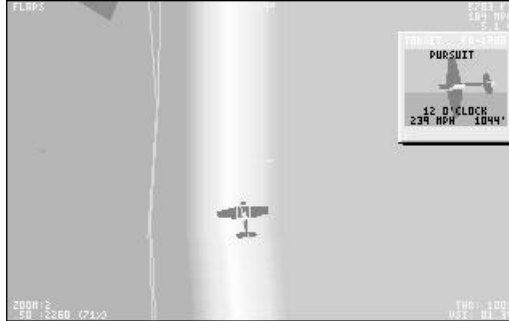

From a close range, jinking can upset the attacker's aim.

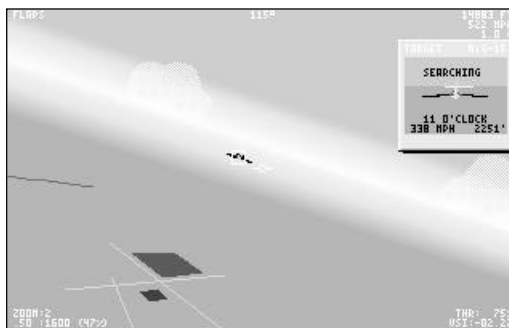

Jinking has less effect at longer range.

## PURSUIT

When an opponent is in "Pursuit," he's turning in order to get onto your tail. When you see Pursuit up in the target window, it indicates more of an intention than a particular set of maneuvers.



*Death was our new trade. We were training to be professional killers. One day at Tonopah, we crowded into the day room to hear an early combat veteran in the Pacific, named Tex Hill, describe his dogfights against the Japanese. Man, we were in awe. Shooting down an airplane seemed an incredible feat.*

## SCISSORS

Scissors are a series of banks along an axis that reduce downrange travel without cutting engine power. The name comes from the criss-crossing motion of both planes — the pursued pilot banks to get his attacker to overshoot him, which calls for a similar reaction on the part of the attacking pilot, which causes the defender to bank the *opposite* direction, and so on. Both pilots weave back and forth as they jockey for the advantageous 6 o'clock position, creating a scissor pattern. The more maneuverable airplane has the advantage in this situation, though the pilot's speed and agility are important factors as well.

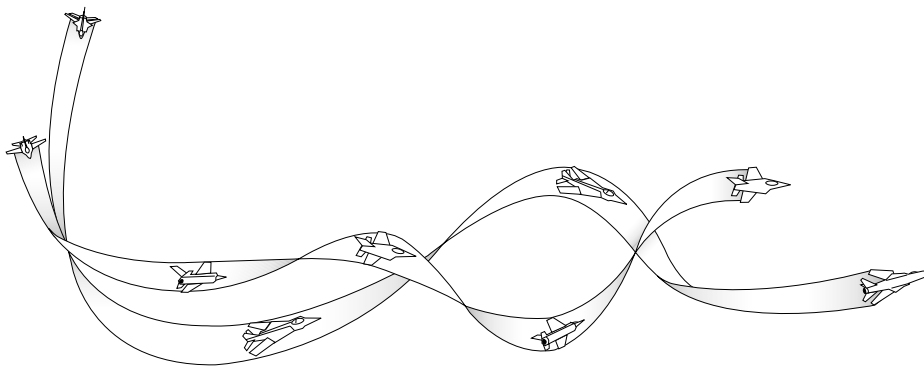

## VERTICAL SCISSORS

This is the same as the Scissors but is performed in the vertical plane — either a climb or a dive.

## LOOP

The Loop has remained a standard evasive maneuver since it was first implemented in World War I dogfights over Europe. It's extremely effective when the attacker is close behind you, but it should be used with caution at longer ranges because of the time it allows opponents to fire on you.

### PERFORMING A LOOP

1. Increase power to 100% and pull back on the flight stick.  
When the inverted horizon comes into view, check your six o'clock (F2 and scan up). You'd better know where he went.
2. When the upright horizon comes into view, return the flight stick to the center position.



### COUNTERING THE DEFENDER'S LOOP

Follow your opponent into the loop, taking any shots at him that you can. You may want to turn your loop into an Immelmann so you maintain an altitude advantage over your opponent. Make sure you keep a close eye on where he's going.

### SPLIT S

Consisting of a half roll and a descent into the second half of a loop, the Split S lets you change heading while simultaneously gaining speed.

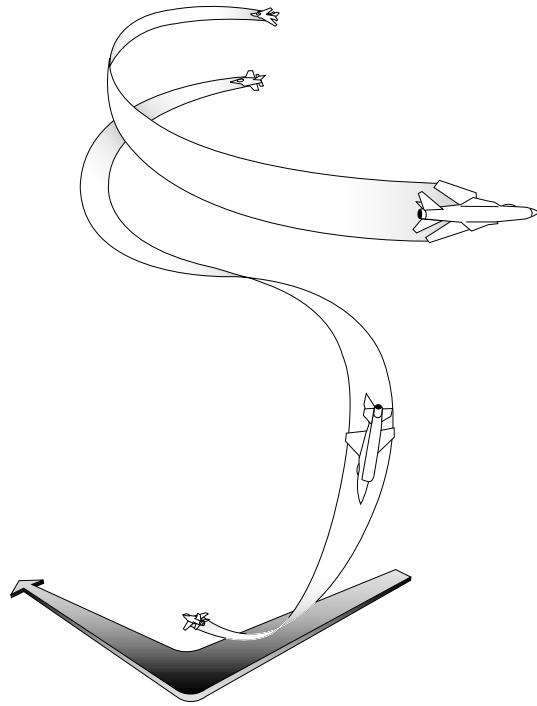

### PERFORMING A SPLIT S

1. Roll the airplane into the inverted position.
2. Once you're in inverted flight, pull back on the flight stick.  
Watch your speed. You don't want to get above your corner velocity. If you need to slow down in your dive, use flaps (press F) or air brakes (press B). If you're still going too fast, drop your landing gear (press G) and/or cut throttle.
3. When the upright horizon comes into view, return the flight stick to the center position.  
If you've lost track of your opponent, use the view keys to spot him.

### COUNTERING THE DEFENDER'S SPLIT S

You still hold the altitude advantage when your opponent goes into a Split S. You can dive after your opponent, wait in the skies above for a more advantageous dive attack, or disengage.

## IMMELMANN

The Immelmann consists of a half loop or vertical climb followed by a half roll. The Immelmann gives you the double advantage of changing heading while simultaneously gaining altitude.

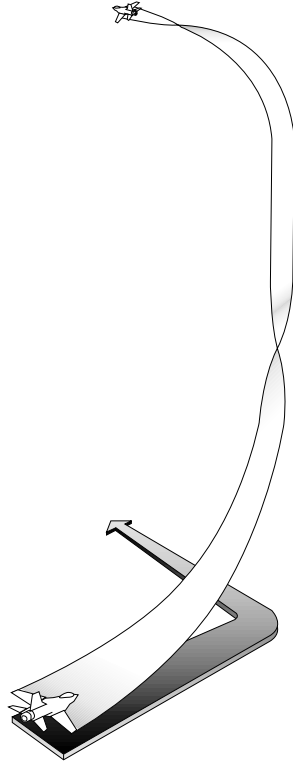

The Immelmann can allow you to make abrupt changes to heading.

### PERFORMING THE IMMELMANN

1. Increase power to 100% and pull back on the flight stick as if you were performing a loop.
2. When the inverted horizon comes into view, return the flight stick to its center position.  
If you've lost track of your opponent, use the view keys to spot him.
3. Pull the flight stick left or right and half roll the airplane to level flight.

### COUNTERING THE ATTACKER'S IMMELMANN

An attacker might pull an Immelmann because he's about to overshoot you or because he holds a speed advantage against your superior maneuverability. If he's about to overshoot you and you have the speed, counter him with an Immelmann of your own. If you don't have the speed to chase him, wait to see which direction he goes when he pulls out of the Immelmann. Dive the opposite direction if you want to disengage. If you want to press the attack, initiate a shallow climb (such that you keep gaining speed) and try to follow his course. The last thing you want to do is leave him with a short route between his nose and your tail.

#### COUNTERING THE DEFENDER'S IMMELMANN

If you have speed, follow your target. There's no use giving him altitude over you. If you don't have the speed to follow him, see *Countering the Attacker's Immelmann* above.

#### LOW YO-YO

The Low Yo-Yo is a shallow dive followed by a sharp climb. Its purpose is to let you pick up speed when you're otherwise unable to close in on a fleeing target. The attacker has the double advantage of making his attack in the target's blind spot.

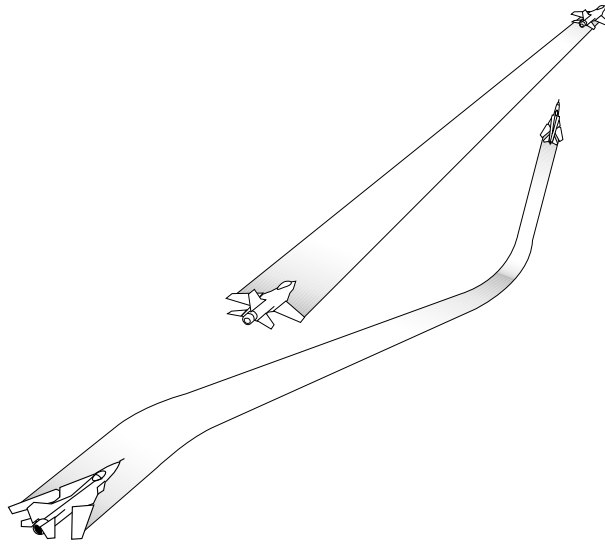

Go into a shallow dive to pick up speed, and then pull up and target the enemy's belly.

#### COUNTERING THE ATTACKER'S LOW YO-YO

If your pursuer is out of range and you suddenly see him drop below you, you can be sure he's attacking with a Low Yo-Yo. Since it's assumed that the attacker couldn't close on you, you have the speed advantage — initiate a climb. This will put distance between you and the attacker. If you feel gutsy, a loop or a High Yo-Yo (Banked Variation) could put you on your attacker's tail.

## HIGH YO-YO

The High Yo-Yo is a steep climb followed by a dive. The climb lets you bleed off power and avoid overshooting your target.

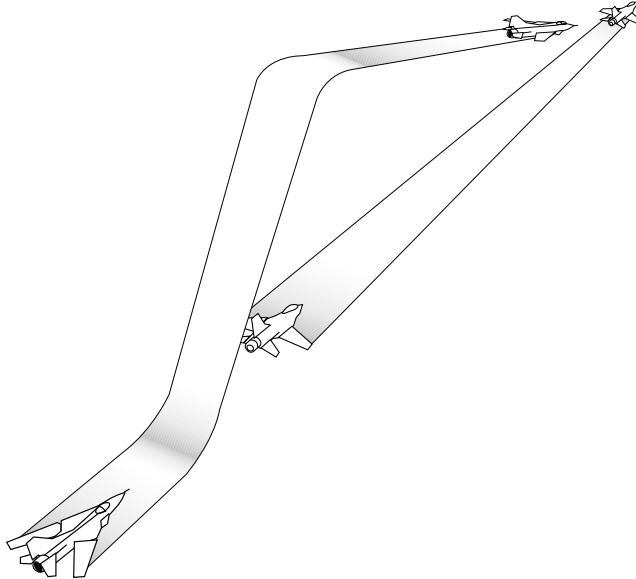

Pull into a climb, and then dive sharply on the target.

## BARREL ROLL

This defensive maneuver throws your airplane into a horizontal corkscrew spin. It's primary purpose is to upset your opponent's aim, but pulling out of the maneuver at an unexpected point could very well shake an enemy off your tail.

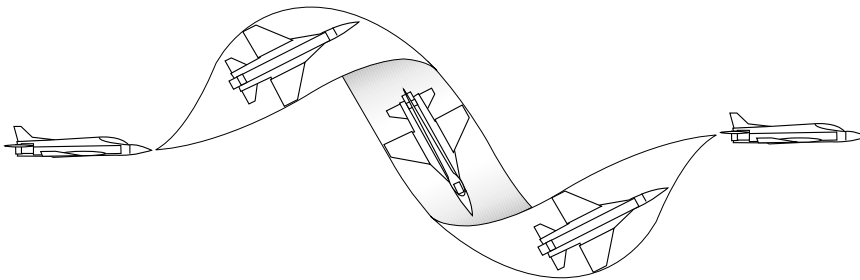

### PERFORMING THE BARREL ROLL

1. Increase power to 100%. Pull the flight stick back slightly, and then move the flight stick right or left to roll the airplane.
2. Complete as many revolutions as you need.

### COUNTERING A DEFENDER'S BARREL ROLL

Following the opponent into the Barrel Roll works. As an alternative, use a straight High Yo-Yo to climb above and come down on your spiraling opponent.





# VARIATIONS FOR ADVANCED PILOTS



## VARIATIONS FOR ADVANCED PILOTS



*It's always better to be the hammer than the nail.*

### LOW SPEED YO-YO (BANKED VARIATION)

The banked variation of the Low Yo-Yo is an offensive maneuver designed to reduce the angle-off between the attacker and his target. While breaking, the attacker goes into a shallow dive and then climbs sharply, coming up on the target's tail.

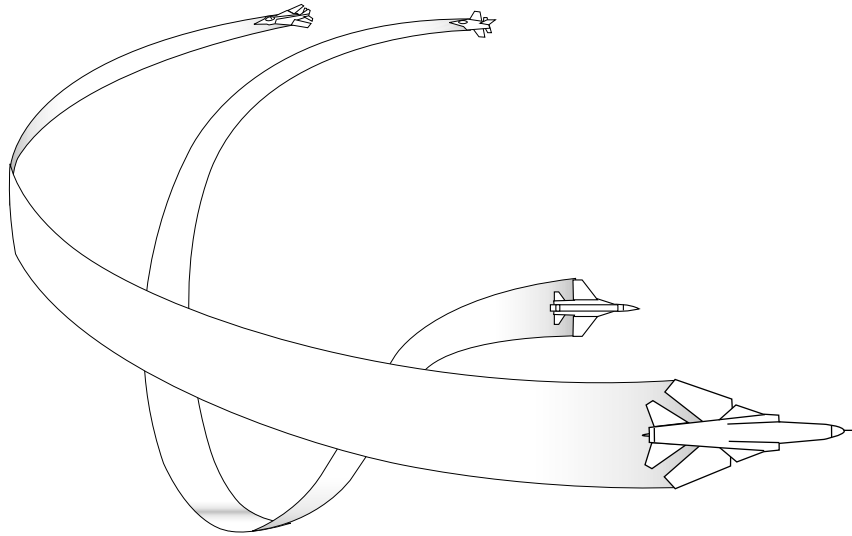

Both High and Low Yo-Yos allow for a quick and severe change in heading. Looked at from above, you can see that the change in heading (horizontal rotation) is increased considerably over the aircraft's normal rate of turn.

### PERFORMING A LOW YO-YO (BANKED VARIATION)

1. Push the flight stick forward to put the aircraft into a shallow dive. Watch your speed. You don't want to get above your corner velocity. If you need to slow down in your dive, use flaps (press F) or air brakes (press B). If you're still going too fast, drop your landing gear (press G) and/or cut throttle.
2. Once you've dived below your target, pull back on the flight stick to begin your climb.
3. On the way up, bank towards target for a clear shot.

### COUNTERING THE ATTACKER'S LOW YO-YO (BANKED VARIATION)

As is often the case, mimicking the attacker's action is a good defense — the defender can attempt to go into the Low Yo-Yo with the attacker. Another useful counter is to continue your break while the attacker dives, and then flip into a Split S, pulling up only when the attacker has begun his climb.

### HIGH YO-YO (BANKED VARIATION)

The High Yo-Yo is like a Low Yo-Yo in reverse — a steep break/climb followed by a dive. Like the Low Yo-Yo, the Hi Yo-Yo also reduces angle-off, giving the attacker a better shot. This maneuver assumes that you have the speed to pull into a steep climb and that you're traveling much faster than your target.

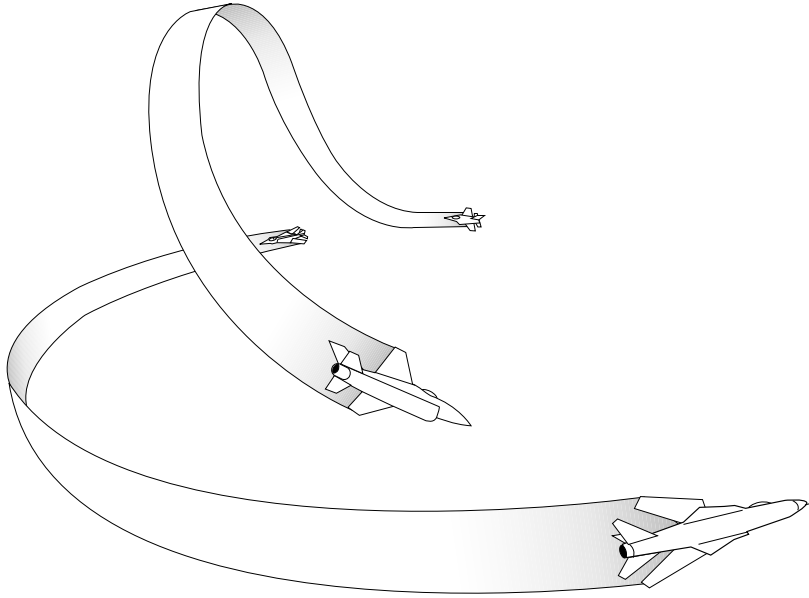

#### PERFORMING A HIGH YO-YO (BANKED VARIATION)

1. Pull the flight stick back to climb.
2. Once you've climbed above your target, push toward on the flight stick to begin your dive.
3. On the way down bank towards the target for a clear shot.

#### COUNTERING THE ATTACKER'S HIGH YO-YO (BANKED VARIATION)

A Split S can be an effective countermeasure if performed right as the attacker begins his climb. Similarly, doing an Immelmann at the beginning of the attacker's dive will also work, especially if combined with an aileron roll and a 90° change in heading.

## ROLLAWAY

Think of a Rollaway as the first half of a banked High Yo-Yo followed by a Split S.

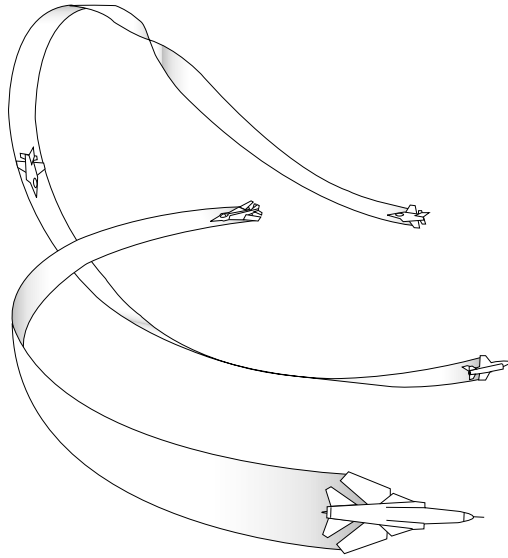

### PERFORMING A ROLLAWAY

1. Move the flight stick right or left to roll the aircraft into a 45° bank, and then pull back on the flight stick.
2. Once you've reached the top of your arc, roll the aircraft away from your opponent's turn.
3. Level off inverted and pull back on the flight stick.
4. When the horizon comes back into view, return the flight stick to center.

## HIGH G BARREL ROLL

The High G Barrel Roll is performed in a turn and, when performed correctly, can quickly transform the defender into an attacker. This maneuver is only effective if the attacker is right on your tail.

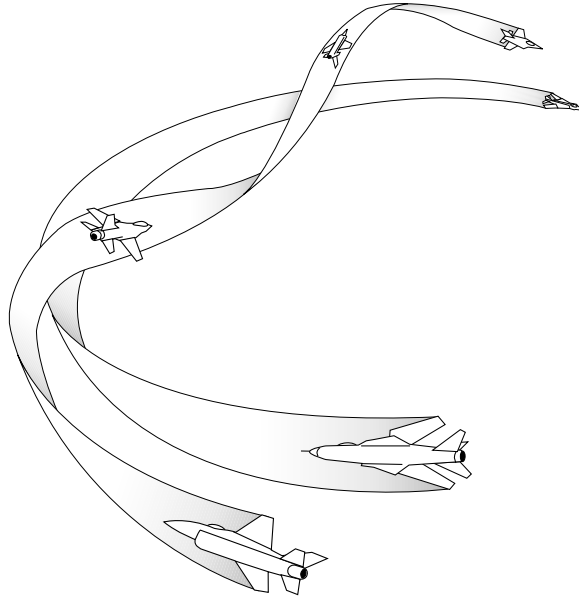

### PERFORMING A HIGH G BARREL ROLL

1. Pull the flight stick right or left to roll the aircraft into a 45° dive or climb. You want to break across your opponent's flight path.
2. Initiate a Barrel Roll away from the turn.

### COUNTERING AN ATTACKER'S HIGH G BARREL ROLL

Use a straight High Yo-Yo to climb above and come down on your spiraling opponent.

## BARREL ROLL ATTACK

The Barrel Roll Attack lets the attacker avoid an overshoot when his target breaks.

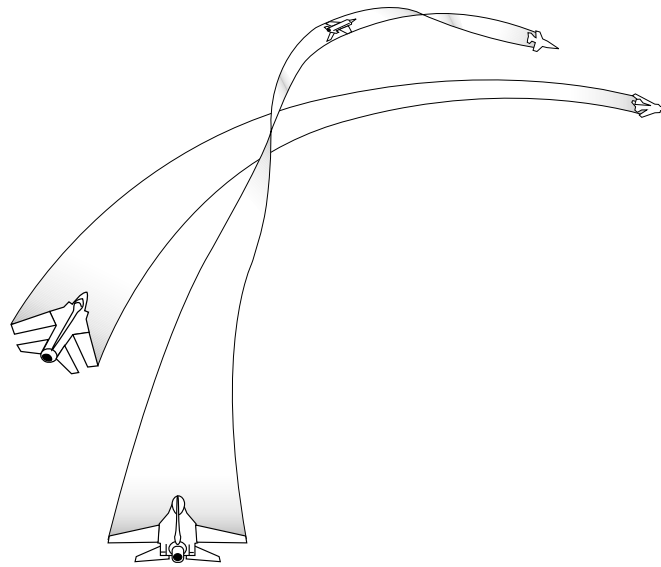

### PERFORMING A BARREL ROLL ATTACK

1. As soon as the opponent breaks, level off.
2. Pull back on the flight stick to pull up the nose.
3. Initiate a Barrel Roll *away from* the target's break.
4. Pull in behind the defender again.

### COUNTERING AN ATTACKER'S BARREL ROLL ATTACK

Your best bet in countering a Barrel Roll Attack is to reverse your break, thus cutting across his path (scissoring). A more dangerous alternative is to dive *away from* the attack.

## SPIRAL DIVE

The Spiral Dive is just what the name says — a spiralling dive to the floor. This is a hard defensive maneuver and is, in fact, dangerous — a skilled attacker can easily follow the defender down, taking as many opportunity shots as he can.

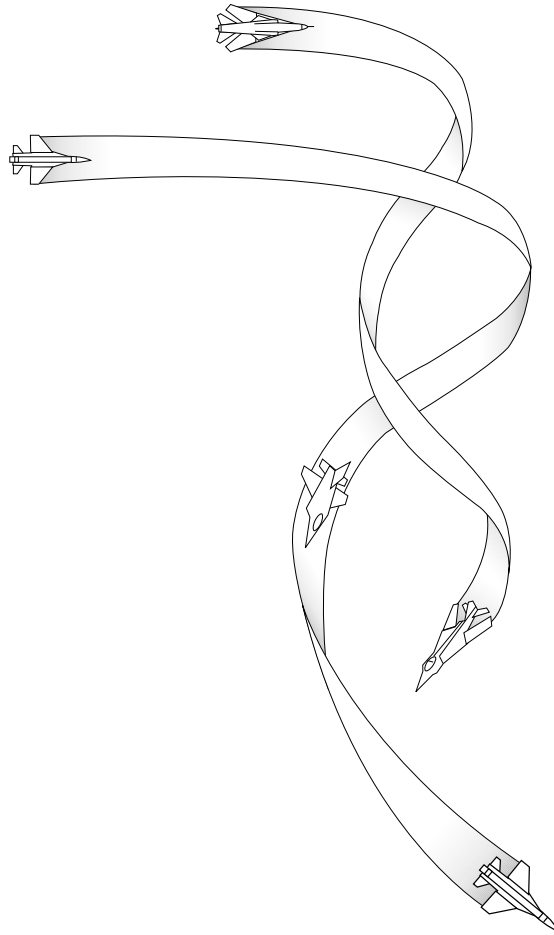

### PERFORMING A SPIRAL DIVE

1. Move the flight stick to the right or left, and then push it all the way forward. When the ground fills your forward view, pull the stick back to center (however, maintain the right or left roll).
2. Watch your speed. You don't want to get above your corner velocity. If you need to slow down in your dive, use flaps (press F) or air brakes (press B). If you're still going too fast, drop your landing gear (press G) and/or cut throttle.
3. Let the attacker overtake you in the dive.

### COUNTERING A DEFENDER'S SPIRAL DIVE

The initiative is yours. You can drop flaps (press F) and/or air brakes (press B) and dive after him, or you can wait above and look for a better attack opportunity. Whatever you do, keep the pressure on him.



REV STEP



37217

# GUNNERY SCHOOL

## GUNNERY SCHOOL



*You're a confident hunter and with a rock-steady trigger finger. You pick your spot — slightly below, so you can pull up, lead him a little, and avoid being hit by burning metal when he disintegrates...*

Aerial gunning is an art, but one that can be learned with patience and practice. Shooting a fast-moving target from an equally fast-moving platform is considerably more complex than shooting a slingshot at an empty bottle. The factors that come into play are:

- Target range
- Flight path
- Deflection angle
- Holdover angle
- Leading
- Gun sight type

Each of these factors are discussed below assuming you have the simplest kind of gun sight — one that does not account for any of these factors.

## TARGET RANGE

Improved guns notwithstanding, fighter pilots rarely hit targets beyond 4500 ft. At ranges of 2625 ft or less, they stand an excellent chance of hitting their opponents with low deflection shots. Target range affects all other factors, and these effects will be described in the following sections.

## FLIGHT PATH

Bullets fly straight after you shoot them. That may sound obvious, but seeing this in a dogfight can be disconcerting to novice pilots. If you're on an enemy's tail and both of you are in a tight turn, your bullets will fall far behind him even though he's steady in your sights.

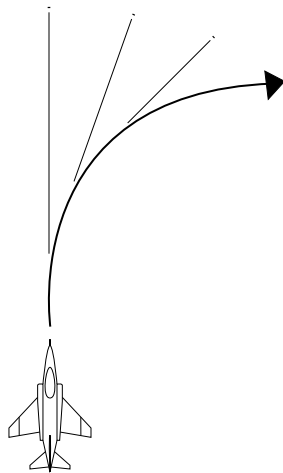

The rule is, the more g's you're pulling, the harder you're turning, and the farther your bullets will fall behind. The effect of your flight path (the amount of g's you're pulling when you fire) is the most important consideration in firing your guns.

## DEFLECTION ANGLE

The deflection angle is the angular difference between your flight path and that of your target. An airplane flying directly away from you has a deflection angle of  $0^\circ$ , while an airplane flying perpendicularly across your nose has a deflection angle of  $90^\circ$ . The higher the deflection angle, the harder it is to hit the target because it spends less time crossing your visual field.

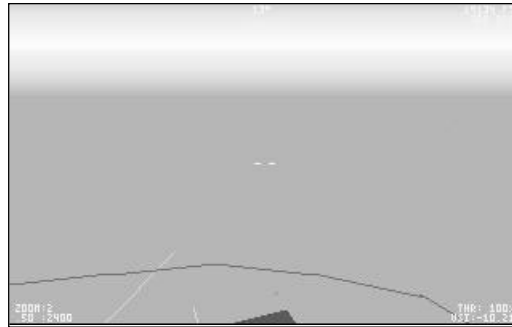

A  $90^\circ$  deflection angle is the hardest to hit

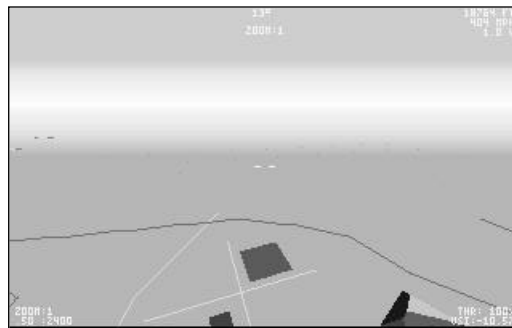

$0^\circ$  deflection angle — an easy kill

Basically, if your target is flying directly away from you, your bullets follow him and have the best chance of hitting. If he's flying across your flight path, however, and you fire your guns when he's in your sights, he'll be long gone by the time the bullets reach where he was when you fired. The more deflection angle there is between you and your target, the farther your bullets will fall behind. The deflection angle is the second most important consideration in firing your guns, and it doesn't have nearly as much effect as flight path.

## HOLDOVER ANGLE

The holdover angle is the effect gravity has on the path of your bullets. When you fire your guns, gravity pulls them down so they go lower than your gun sight indicates. In the close ranges you deal with in dogfighting, however, this effect is so small compared to the others that it can be safely ignored.

## LEADING

With most gun sights, you have to adjust for range, flight path, and deflection angle on your own. To do this, you *lead* the enemy, which is to say you aim your gun sight where you believe the enemy will be after the bullet covers the distance between you.

The single most important factor you need to account for is flight path. The more g's you're pulling, the farther *ahead* of your enemy you must aim to hit. If he has a high deflection angle, you must aim even further ahead of him. If he is at extreme range, you have to aim even further ahead. All these factors require practice to master, and even the best aces aren't perfect at performing these on-the-fly estimates.

Some gun sights account for flight path and range, others don't. You have to know what type of gun sight you're using before you can accurately guess how much you must lead your targets.

## GUN SIGHT TYPE

### World War II

These airplanes had the simplest gun sight possible — it shows you exactly the direction the bullets fly the instant you fire them. You have to adjust for range, flight path, and deflection angle on your own. This type of dogfighting requires the most leading.

### Korea

These airplanes have the ability to adjust for flight path, so half the battle is solved by the *pipper* (the circle-shaped sight). This pipper determines how many g's you're pulling and moves to compensate for your flight path, but it assumes that the target is 1200 feet ahead of you. If the target is farther away than that, you must manually lead the target a little to account for the increased range. Likewise, if the target is closer than 1200 feet, you must *trail* the target a bit. Additionally, you must always manually adjust for deflection angle if appropriate. (Otherwise, if your target happens to be exactly 1200 feet ahead of you, in level flight, and flying directly away from you, put him in your sight and you'll score direct hits.)

Hint: If you display the Target Window (press Shift-3), it tells you the exact line-of-sight distance between you and your target.

### Vietnam

These airplanes have a sight similar to those used in Korea, with the additional advantage of radar. If your radar is turned on, the gun sight determines the exact range of the enemy and uses that in its flight path calculations. The only adjustment you have to make is for deflection angle. If you do not have your radar turned on, the gun sight works exactly like those in Korea.

## THE SECRET TO A SUCCESSFUL STRIKE

Get closer. When you think you're close enough, get even closer. If the target doesn't know you're there, let him fill your field of view before you open fire. The closer you are, the less leading you have to do, and the more bullets will rip through his airplane.





REV STEP



37204

# FIGHTER TACTICS

## FIGHTER TACTICS



*There's no joy in killing someone, but there's real satisfaction when you outfly a guy and destroy his machine. That's the contest: human skill and machine performance.*

This chapter is about fighter tactics and how to use Air Combat's controls to your advantage. Some of the tactics described here are good principles of air combat that fighter pilots have developed and respected over the years. Other tactics may only apply to the era you're flying in.

The chapter is divided into sections that describe four phases of air combat, without which any discussion of air warfare is incomplete. The four phases are:

- Detection
- Closing
- Attack
- Maneuver

At the end of the chapter, you'll find more sections with specific approaches to evading missiles and attacking bombers and ground targets.

## DETECTION

Locating the enemy before he locates you gives you the initiative. The cunning pilot knows that early detection lets him stack as many odds in his favor as time allows — altitude, speed, relative position, correct weapon choice — giving him a large advantage over his opponent.



*In World War I, detecting the enemy was simply a matter of having good eyesight, knowing what to look for, staying alert. Since then, other means of detecting the enemy have been introduced. Formation flying and radio communications have increased the individual pilot's awareness by adding more "eyes in the sky." It's obviously more difficult to sneak up on a formation than on a guy flying alone. Then, from World War II on, you saw the use of ground radar, which helped point fighter aircraft in the direction of incoming enemies. Now fighters themselves carry radar and scan long range for targets.*

## VISUAL DETECTION

The View keys are among the most important tools in the game. F1-F4 can be pressed fairly quickly — you should make a habit of doing just that when you're not too busy dogfighting. You don't have a wingman, *so keep your eyes open!*



*In a sky filled with airplanes, I needed to keep my head on a swivel to avoid getting hit, being shot down, or running into somebody. The best survival tactic always was to check your tail constantly and stay alert.*

The Scan keys are effective, too, especially when used with Forward View (F1). The Forward View is the *only view* from which you can target an opponent.

To get a fast 360° scan of the horizon, press F2, and then use the right/left arrow keys to rotate your view in a complete circle. Note, however, that your belly is still a blind spot and you're vulnerable if you rely only on this means of visual detection.

**OF SILK AND SIXES**

A silk scarf is the trademark of fighter pilots, but it's not worn just to impress a barmaid. The tradition goes back to the earliest days of air combat, when World War I pilots climbed into their wood and canvas crates and took to the sky. At 10,000 feet in an open cockpit, the desire to stay warm is understandable. But fighter pilots soon discovered that wearing a wool scarf wouldn't cut it. Actually, the problem was that wool cut too much — namely the pilot's necks. In the course of a mission, a fighter pilot turned his head so often to check his six that a wool scarf made his neck raw. The logical solution to the problem — something that would keep them warm but not chafe their necks — was silk.

**ZOOM OUT WHEN YOU'RE HUNTING FOR TARGETS**

You want the widest possible view while searching for targets. Zooming out to 1 increases your field of vision. Press the minus (-) key to zoom out. Use it and spot the bandits early.

**ZOOM IN FOR "YEAGER VISION"**

If an airplane is too far away to identify, press the plus (+) key to zoom in. If this feels like cheating, remember that most aces have above average eyesight. Yeager's, for instance, is still 20/10 — double that of the normal human.

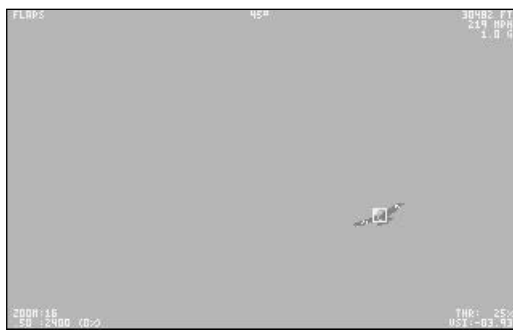
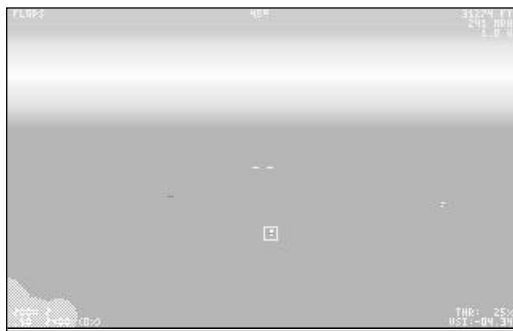

*My biggest tactical advantage was my eyes. I spotted him from great distances, knowing he couldn't see me because he was only a dim speck. Sometimes he never did see me — or when he did, it was too late.*

### USING THE TARGET WINDOW

When used properly, the Target Window can provide you with more than just detection information — it contains data that's useful in all phases of air combat.

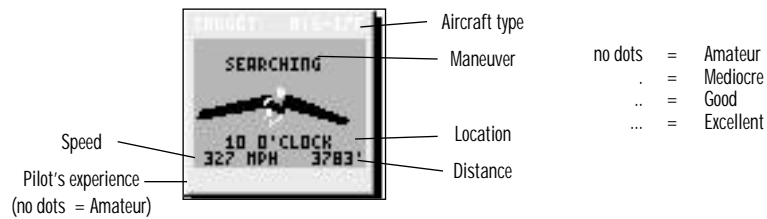

The Target Window shows the targeted aircraft as he appears to you or *would* appear to you if he were in visual range. Though subtle, this visual information communicates a lot about his relative position to you.

1. You can see if he's moving toward or away from you.
2. You can tell if he's above or below you by the color of the background. If you can see the ground behind the target, you're above him; if blue sky is blazing over his airplane, he's above you. If the target window is split, the target is at a more or less equal altitude.
3. You can estimate his heading. For instance, in the target window below, the airplane (which is in front of you) is veering to your right.

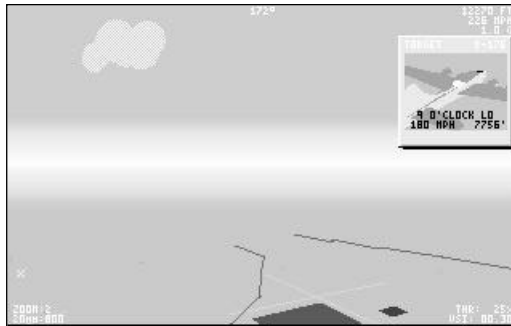

Around the airplane view is other useful information — the type of airplane as well as its location, speed, and range. The maneuver currently being performed by the target also appears at the top of the window. Anticipating your enemy's next move is never easy, so knowing what he's up to gives you a huge advantage.

Hint: Since this is considered a help feature, you may want to use F7 and F8 views instead to get a sense of where the enemy is in relation to you.

**RADAR**

Radar transmits high frequency waves in a 90° arc off the nose of your airplane. These waves reflect off of objects and return to your signal receiver, which translates the waves into objects with specific size, range, and heading. Your radar unit can sense targets at ranges of up to 60 miles.

Be careful! Switching on your radar is like lighting a torch in a dark room. Enemies *everywhere* are guaranteed to sense your active radar, and they'll know your position and range, too. Though you can use radar *briefly* to detect enemies, you'll need to turn it on for extended periods when firing radar-guided missiles. Your lead-computing gun sight also needs radar to calculate the target's range.

**AIR COMBAT'S SPECIAL DETECTION**

The help windows can give you extraordinary powers of detection.



The Map Window (Shift-1) shows you the general direction of all friendly and hostile aircraft around you — it's actually better than radar because no enemies know you're using it. This is not unlike modern AWACs.

**DIRECTION TO NEAREST ENEMY**

You can know the clock direction to your nearest enemy by pressing Ctrl-Z. His location will appear in the Warning/Communications line at the top of the HUD.



*You've got to really pay attention to who's friendly and who's not. When I shot down those four 190s, there were about 150 Me-109s and 50 FW-190s — that's 200 fighters — versus our P-51 group, which was about 46 airplanes. And all at once, there's airplanes going every which way in the sky! You really got to watch out — guys getting on your tail, mid-air collisions, that sort of stuff.*

**CLOSING**

There is no golden rule for closing in on a target except that you want to maintain the element of surprise if possible. To do this, you want to stay out of sight and move quickly.

**APPROACH FROM THE TARGET'S BLIND SPOT**

Fighter pilots will typically see you if you're anywhere in front of them, so you should approach them from the rear. The inexperienced pilot won't be checking his six as often as he should. The fighter pilot's blind spot is below and behind his airplane, and this is a good direction from which to close.

If your radar is on, fighters with radar will detect and instantly know your location. The moral of the story — don't flip on your radar switch until you're ready to fire, and be prepared to act if your missile fails to hit.

Bombers can see in all directions, so there's no way to approach them without their knowing it.

**SLASH ATTACK**

It's obvious that the less time you spend closing, the less time your target will have to spot you. This is one way in which an altitude advantage is important. Altitude is a reservoir of energy that can be quickly turned into speed by diving. Not only do you close in on your target swiftly, the dive leaves you with a high store of kinetic energy that can be used for other maneuvers — a Climb, Yo-Yo, etc. — or to escape if the odds aren't in your favor.



Speed is all important in the attack phase. An airplane won't even need maneuverability if the attack is fast and the pilot is accurate. If your airplane is very fast but not as maneuverable as your opponent's, you can use repeated slash attacks to avoid a dogfight.

#### THE IMPORTANCE OF SURPRISE

It's estimated that some 80% of air combat victims were never even aware they were under attack until they were already plunging toward the earth. The romantic image of air warfare as a civilized duel among sporting individuals withers next to this astonishing fact. Air combat may be the ultimate challenge, but fair play is not the rule. Air combat is and has always been a life and death event, one which the successful fighter pilot will do anything to survive. If this means shooting an unwary opponent in the back, so be it.

If anyone believes that air warfare was not always such a cold, calculating affair, it should be remembered that the premier ace of World War I, Manfred von Richtofen, made a career of circling high above the swirling dogfights, diving only on the unwary stragglers who'd left the safety of their squadrons.

#### ATTACK

Once the attack begins, there's no going back. As Yeager says, "If you get an advantage, you've got to press it home."

#### GUN ATTACKS

##### Vulnerability Cones

For fighters with fixed, forward-shooting guns — the "norm" in fighter design after World War I — a target's angle of deflection is important (see *Gunnery School* for a complete explanation).

For fighter pilots in all wars, the maximum angle of deflection has remained around 45°. At an angle of 45° or less, most pilots stand a chance of keeping their sights on their target and hitting it. This angle forms the target's *vulnerability cone*.

Naturally, the smaller the angle of deflection, the better the attacker's chance of hitting his target. Within a few precious degrees, the attacker's chance of hitting rises dramatically. This is the target's *lethal cone*. Improvements in gun sights have increased the size of the target's lethal cone from 15° in World War II to 30° in Vietnam.

For more on making successful gun attacks, see *Gunnery School*.

#### ATTACKING WITH MISSILES

In Vietnam, the actual kill rate with missiles was very low, which was one reason why the gun was later installed on the F-4 Phantom. Even so, your Vietnam era airplanes are equipped with missiles, and you should use them in combat — you have nothing to lose, and you could score an easy kill with one.

Missile ranges are summarized in the following table:

Missile	Max. Range	Min. Range
Sparrow	4 miles	1 1/2 miles
Sidewinder	2 miles	1/4 mile
K-13 Atoll	2 miles	1/4 mile

Within the minimum range, your missile doesn't have enough room to get a lock on the target and detonate properly.

### Radar-Guided Missiles

The Sparrow is guided by radar waves emitted by your radar and reflected back off the target. Your radar must be on and you must maintain a target lock while the missile is in flight. Note, however, that you can select a new target while the missile is in flight. The new target must be within the missile's seeker in order for it to track. Since Sparrows have a longer range than heat-seeking missiles, you should use them for long-distance attacks (from any direction) and save your Sidewinders for in-fighting. Because of the sensitivity of the seeker on the missile, it's useless to fire a missile in a turn greater than 3 g's.

### Heat-Seeking Missiles

Sidewinders and K-13 Atolls are fire-and-forget weapons — once they're launched, they either hit or they don't. Nevertheless, you should not fire until you have a target lock. You must be behind your opponent and in full view of his engines. Because of the sensitivity of the seeker on the missile, it's useless to fire a missile in a turn greater than 3 g's.

Heat-seeking missiles can be distracted by other heat-emitting object such as the sun and tropical jungle floors. Hitting targets below the horizon or in the sun can be difficult.

### TRACKING ANOTHER OPPONENT WHILE YOU ATTACK

If you're closing on two enemies, chances are they'll break in opposite directions when you attack. You want to press your attack on one of the planes while keeping an eye on the other. Here's a trick. Target the opponent you AREN'T following. Once you've shot down the untargeted plane, the target marker will tell you where to find the other plane.

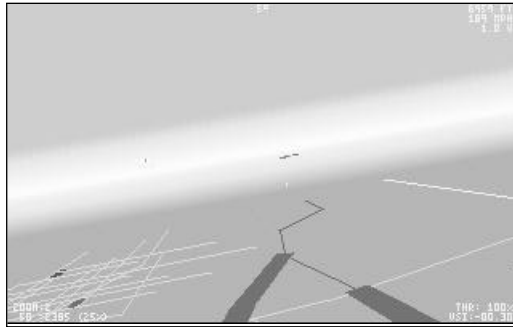

Attack the airplane that isn't targeted.

### LET YEAGER BE YOUR WINGMAN

When you're concentrating on your attack, it helps to have a wingman who can check six for you. Let Yeager alert you to bandits on your six. Press Shift-4 to turn the Yeager Window on and off.

"Bandit on your six!"



## MANEUVER

When an initial attack fails and the element of surprise has been lost, each pilot performs a series of maneuvers and counter-maneuvers until one opponent successfully disengages or is shot down. This maneuvering phase is what's traditionally known as the *dogfight* — the relatively but intensely active period in which each pilot twists and gyrates in an attempt to get into his opponent's cone of vulnerability.

Though air combat is complex, random movement will not win the day. At any given point in a dogfight, there are good and bad maneuvers — a wrong response to a situation can spell a pilot's death if luck isn't on his side. Nonetheless, no air combat scenario is scripted from the start. It's the individual pilot — with his own experience, awareness, and ability to handle his equipment — that makes every air combat encounter unpredictable.



*Dogfighting is a clean contest of skill, stamina, and courage — one on one.*

## PURSUIT

Pursuit can be difficult once the target has moved off of the screen. Here are some ways to overcome this difficulty.

### USING THE TARGET MARKER

Whenever a targeted opponent is not in forward view of your cockpit — that is, he's above, below, off to a side, or behind you — a small X (the target marker) indicates which direction you need to travel in order to get back into a firing position. This direction is the *shortest possible route* between the nose of your aircraft and the enemy plane. Note that this is not *necessarily* the best route — at low altitudes, you could auger in following the shortest route to your target!

If your primary objective at the moment is to *bring the enemy into view*, bank until the target marker is at the top of the screen, and then pull back on the stick until the marker is in the center. Once you get him into your sights, let him have it.

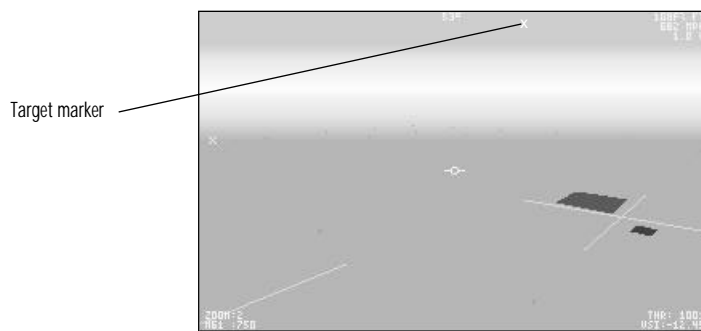

### Using Plane → Target View to Pursue

If your opponent is nearby but off of the screen, you can use the Plane → Target view (F7) to continue following him (remember, the opponent must currently be targeted). With this view, you'll know immediately if he reverses direction.

### Using Up 45° View in a Turn

When you're hard on your opponent's tail and turning with him, you can use the Up 45° view to quickly see how close he is. If he's *real* close, you may want to drop air brakes or flaps to bleed off a little speed — this will give you a tighter turn and pull him into your gun sights.

Note: You could ease off on the throttle, but flaps act more quickly. You also don't have to waste time later bringing your engine back up to speed.

**Remember, F1 always gets you back to Forward view.**

### ALTITUDE VS. SPEED

Fighter pilots have a saying: "Speed is life." By this, they don't mean that going faster is always better than going slower. If you're going so fast that you overshoot your opponent, you've defeated the purpose of maintaining speed.

The "Speed is life" maxim is simply a reminder that you always want to have enough speed to maneuver in any direction. Too much speed means that you can't turn quickly — you're barreling along but you can't pull the g's. Too little speed means that you can't climb or turn at all — all you can do is peter along in level flight.

It helps to imagine a fighter's speed as a limited resource, just like its fuel. Climbing and hard maneuvering "cost" the pilot speed as his airplane fights gravity and drag. The engine gives you back some of this lost speed, but you may be maneuvering too hard to get it all back. You begin losing speed at a faster rate than you replace it. What do you do?

In air combat, an airplane's "energy state" is more important than its speed. Your energy state is the combined energy of your speed *and* your location. Your airplane's altitude is an energy resource you can use. Since your airplane once traded energy for altitude — it "spent" energy climbing — you can trade altitude for energy by diving.

The fact that altitude can be converted into speed and maneuvering power is why Yeager says, "Keep as much altitude advantage as possible." Altitude is a *real* advantage. Your opponent must expend energy to come up after you, while you have the option to make a slashing dive attack.

Some general rules can be formulated from the energy state concept (if you remember that all rules have to be broken on occasion):

- Don't waste energy on maneuvers that don't have a use
- Climb when you can
- Dive if you need the speed
- Watch where you are in the envelope — don't start a maneuver that will leave you going too slowly



*You fought wide-open, full-throttle. With experience, you knew before a kill when you were going to score. Once you zeroed in, began to outmaneuver your opponent while closing in, you became a cat with a mouse. You set him up and there was no way out: both of you knew he was finished.*

### MISSILE EVASION TECHNIQUES

As soon as you detect a hostile missile, you should drop the appropriate countermeasure devices: flares if it's a heat-seeking missile, or chaff if it's a radar-guided-missile.

Your next move should be a hard defensive break. Missile seekers have narrow fields of vision. Infrared missiles can easily lose their lock once your engines are out of their sight. The break will be less effective against radar-guided missiles, but if you turn sharply, they may not be able to turn with you.



*Watch your fuel in a dogfight. It's an easy enough mistake for inexperienced pilots.*

### ATTACKING BOMBERS

Bombers don't have the speed and agility of fighter, but they are typically well-armed and, with so many eyes on board, are never surprised. To increase your chances of survival, you must stay out of as many gun sights as you can and come in at an angle at which the gunners have the least chance of hitting you. To do this, you have to know where the turrets are on your target.

### GUN MOUNTS

Guns can swing in 60° horizontal and vertical arcs.

### HIT PROBABILITIES

Due to the fact that a bomber is moving forward, an individual gunner's chances of hitting you vary depending on his location. Note, however, that all gun positions have a smaller chance of hitting you the harder you're maneuvering (climbing, diving, or turning).

### FRONTAL ATTACKS

With combined closing speeds of over 500 mph, the gunners' chances of hitting you are not good. In addition to firing on a quickly approaching target, they must cope with the thought that if they actually destroy you, large pieces of your disintegrating airplane could hit them!

### FLANK ATTACKS

The waist-gunner of the B-17 is going to have problems hitting you. His gun, which he must move by hand, is sticking out into a 200 mph wind. He must not only fire into this wind, he has to compensate for any difficult deflection angle you put between you and the bomber. Expect waist-gunners to hit less often than any other.

### REAR ATTACKS

The rear gunner has the best chances of hitting you. With your plane closing at around 100 mph, he has plenty of time to take his aim, and a power-operated turret only makes his job easier. In addition, he's packing twin .50 caliber machine guns (B-17) or 20 mm cannons (B-29 and B-52) that can do a job on your little fighter.

### FIGHTER APPROACHES

Avoid rear attacks on bombers, especially if they're in a group or they have experienced crews.

Front attacks require good marksmanship and a lot of courage. Indeed, the Luftwaffe considered head-on attacks the most effective means of shooting down bombers, despite the fact that a lot of time was lost overtaking the bombers for each successive attack.

Some good alternatives to the head on-attack is to approach from the sides due to the relative impotence of the guns there. An extremely skilled pilot could even slip in horizontally between the areas the turrets cover. Of course, this approach doesn't take into account the guns on other bombers in the group. The top and bottom of the bombers are entirely defenseless; however, it's difficult to dive steeply on a moving target and still be accurate.

### ATTACKING THE ME-110

The Me-110 is a fighter, but its rear gun can make it difficult to attack using the normal tail-chasing methods. You should approach it from the rear, but *below* it, where the rear gun can't be brought to bear.

### GROUND ATTACK

To attack a ground target, go into a shallow dive while trying to keep the target in your gun sights. The more shallow your dive, the more gradually you can pull up your nose and the more accurate your shooting.

You may want to slow down when making your strafing run. Be careful! You don't want to go so slowly that you can't respond to an unexpected attack from an enemy airplane.

### Hint

As you make your approach, increase magnification (press +). The bigger your target on the screen, the better your aim. Be careful maneuvering while the target is magnified — it's much easier to auger in when you don't have a sense of your true distance from things.

Target spotted

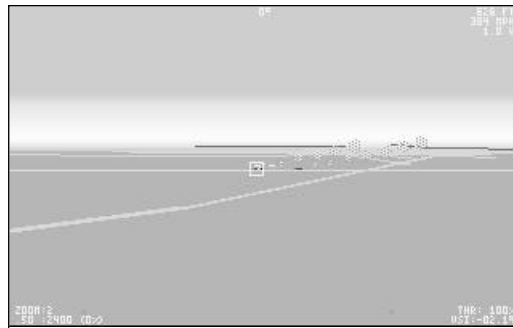

Increase magnification for easier shooting

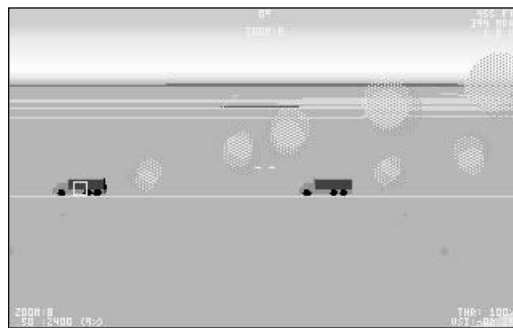



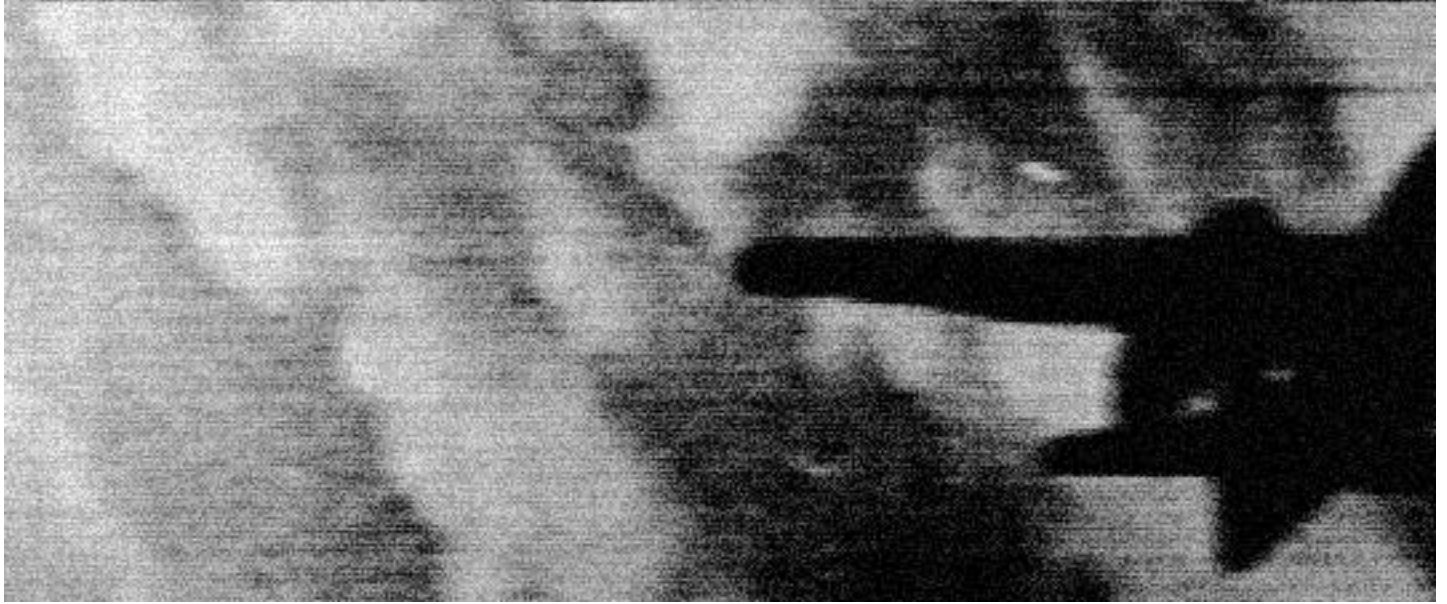
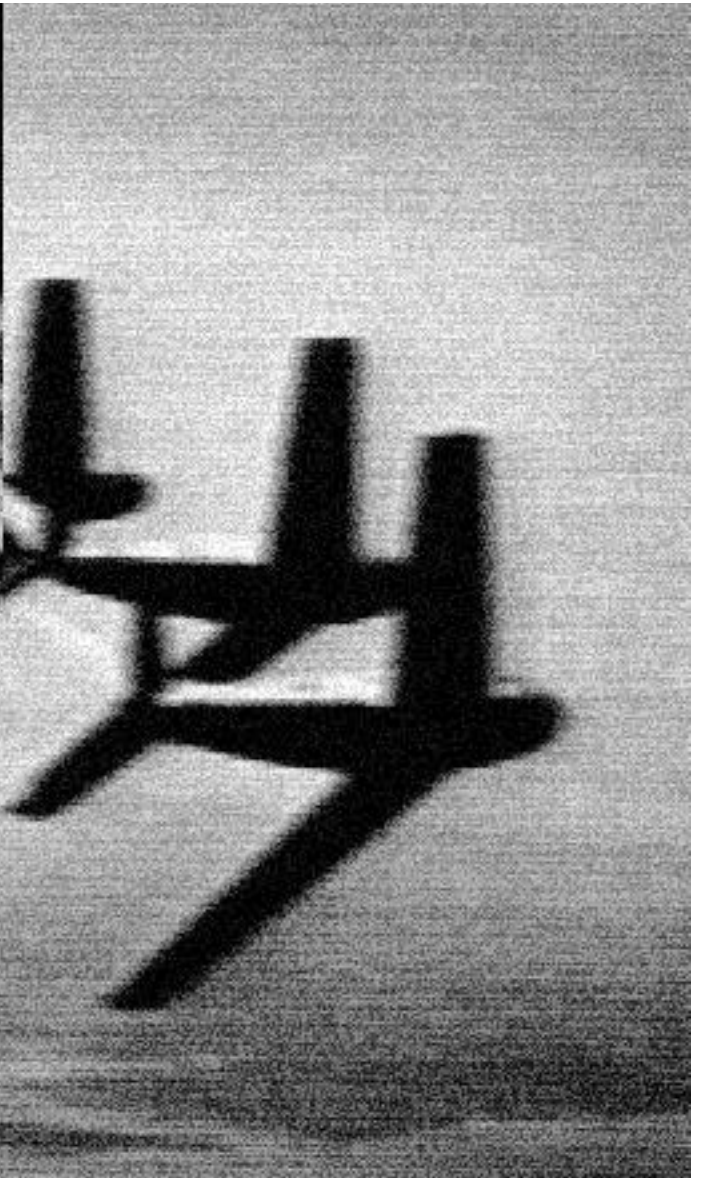
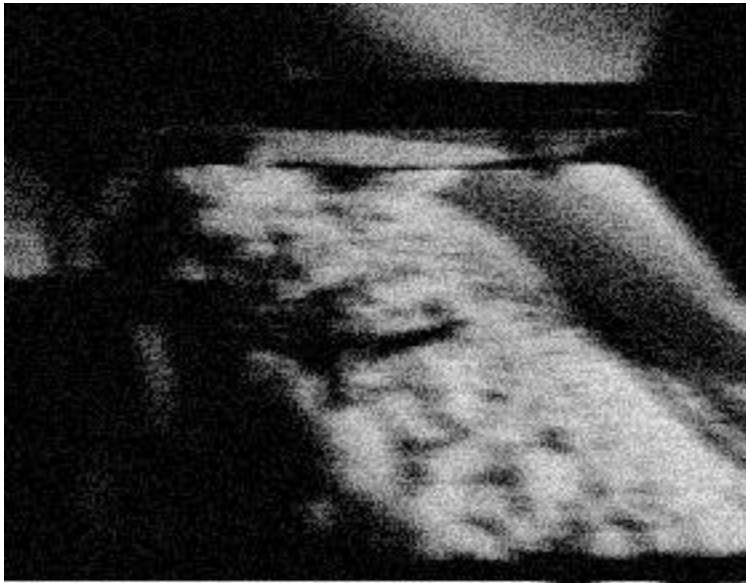



# AIR COMBAT IN 3 ERAS

## AMERICA ENTERS WORLD WAR II

In mid 1942, the U.S. entered the the air war in Europe when the 8th Army Air Corps came to the aid of the beleaguered RAF. After early bombing missions on targets in occupied France, the bombing crews soon shifted their focus to Germany itself, and in early 1943 they launched their first assault. The allies agreed that the Americans would conduct day raids, while the RAF worked the night-shift to keep the pressure on the Nazis around the clock. The sixty-four B-17s and B-24s of the first American strike force showered bombs on the city of Wilhelmshaven. The Luftwaffe, taken by surprise, lost seven fighters defending the city, and brought down only three U.S. bombers.

Germany was too far away for any sustained fighter escort, so the American bomber command employed the combat box formation, which in theory allowed them to bomb with maximum precision while providing protection from enemy fighters. The combat box consisted of three 18-plane wing formations staggered at separate altitudes, the mid-level wing flying just ahead of the others, to top-level off to the right of it, and the low-level off to the left. The result was an expanse of heavily-laden, four-engine bombers one mile wide, a half mile deep, and some 600 yards long.

These flying armadas came at intervals of about six miles, and heavily armed with twelve .50 caliber machine guns, would attempt to blast their way into German airspace, unload their bombs, and turn for home. The bombers presented lethal danger to the German fighters, because of the numerous, powerful turret-mounted guns. No matter which way they approached from, the Messerschmitt pilots were bound to meet a tremendous barrage of return fire from unescorted B17s and B24s. But as they were turning around, the formations tended to become scattered; it was then that the Messerschmitt pilots maximized their chance of scoring kills. When the bombers reached the fighter escorts synchronized to rendezvous with them, the pilots could breath more easily.

The Luftwaffe employed a number of different new weapons to combat the formidable American bombers. Among these were pre-set bombs timed to detonate when they reached their targets. Such devices, though potentially devastating, proved unreliable. It was the introduction of wing-mounted rockets on the Messerschmitts that caused real problems for unescorted bombers. These long-range rockets allowed the German fighters to attack out of range of the bombers' .50 caliber guns, and the rockets had an effective explosive range of about 50 feet. It was not uncommon for one bomber, hit by the blast from a rocket, to explode and take out another bomber. It turned out that the greatest virtue of rockets was their ability to break up bomber formations and so make individual planes more vulnerable to fighter attack. All things considered, the 8th Army Air Force grew increasingly aware that it was losing too many unescorted bomber.

The bombers eventually got their escorts, the legendary P51-Mustang. By the spring of 1944, the P51-D, which carried six guns, had an effective range of 1200 miles and could fly for a full nine hours. In addition, its performance was better than Germany's best Me-109, thus posing an even more serious problem for the Luftwaffe.

Along with the Mustang flew the heavily fortified P-47 Thunderbolt. Though it didn't have the Mustang's range, the Thunderbolt was heavily armed and very hard to shoot down. Despite its massive size, it flew as fast on the level as most Messerschmitts, being able to out-dive all of them and zoom to regain height with astonishing alacrity. Of course, in a close in dogfight its relatively poor turning radius made it no match for the smaller fighters, but such encounters were avoidable using the dive-zoom and roll technique. The fortunate combination of Mustangs and Thunderbolts proved instrumental in accomplishing the bombing runs which in fact pounded the Nazis into submission, and therefore shortened the war.

**OCTOBER 12, 1944**

I was leading a squadron of 16 P-51s. We were flying four flights of four, fingertip formation. I was up around 25,000 feet over Steinhuder Lake, and we were ranging ahead of the bombers. There were broken clouds and haze down below us, and I spotted these 22 little specks. It just so happened that at the time I spotted them, I was looking down-sun — that is, I had the sun at my back. And I knew that they had to be Germans because we fly in squadrons of 16 airplanes — we were pretty precise about that. So I kept the sun at my back and kept closing up on them. We still had drop-tanks on our P-51s.

We got up to about 200 yards — I don't think they'd even seen us — and I blew one up, which ran him into another one and took him out of the sky. When the other 109s saw this, they all broke. We punched our tanks off and they went every direction, so I had to break my squadron up into elements of two. Anyway, one guy broke to the left, and so I tried to stay on his tail. I was in close, maybe 100, 150 yards or so, and I was getting good hits on him. And looked kind of out of the corner of my eye, I could see this other 109 slowing down trying to get behind me.

About this time the guy I was hitting blew up. I immediately cut my power all the way back to idle and put in full right rudder and full aileron rolling my airplane right toward him. Then I reversed the turn to roll in behind him. I think the guy was less than 100 feet from me. I just moved out to the left a little and kicked right rudder to make my nose go to the right. I opened up at that range and man I think I sawed him in two.

Now I had one guy forward, and another guy who went for the deck. I followed him down and finally set him on fire. He hit the ground. Now I looked around and we were in the clouds. I still had my wingman, so I looked around for my other guys in my squadron, but of course they were broken up.

So we started back up and I looked up and I'm staring at 16 Focke-Wulf 190s! They ducked into the clouds on me and I couldn't get near them. Evidentially, these 109s thought we were the FW-190s trying to join up with them. Obviously they didn't take a good look at us.

AIRPLANE DESCRIPTIONS

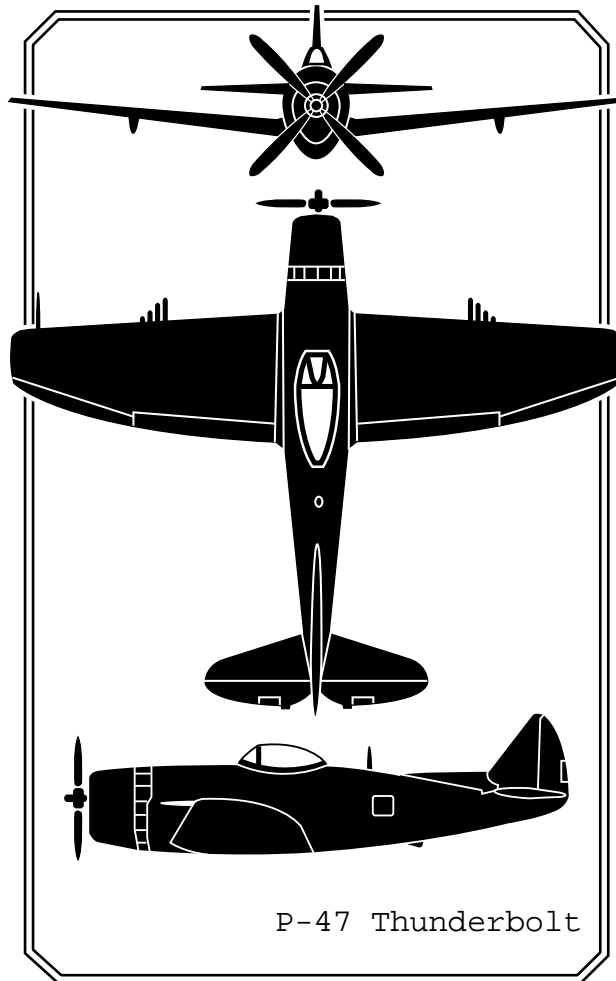

## REPUBLIC P-47 D THUNDERBOLT

In response to the need for fast, well-armed planes able to absorb heavy punishment, Republic began developing an XP-47 in 1939. After much testing and various design changes, the first P-47Ds began rolling off the line in 1942. In all more than 12,600 were built, making it the most produced P-47 by far. What made it so desirable was its versatility as both a fighter and a bomber. Partly in appearance, the P-47 had a rather limited range of little more than 400 miles; but when outfitted with drop tanks and/or other auxiliary fuel supplies, it could travel as far as 1700 miles. This made it into a highly successful long-range escort, a bomber, and a potent ground attack platform in Korea. Many aircraft historians consider the "T-bolt" to be the forerunner of modern, multi-role aircraft.

Another important feature of the P-47D was its radial engine. Earlier models were powered by an in-line motor which, being liquid-cooled, burned out almost as soon as its radiator was punctured. But the air-cooled, radial engine held up well under fire.

The first XP-47 prototype bore only two guns and was relatively light in design, being exclusively a fighter. As the model evolved through A, B, and C series, guns were added and the design became more and more rugged, modifications reflecting current military needs. More widely used than any other fighter in WW II, the P-47 D carried eight .50 inch guns and was a whale to bring down. Robert S. Johnson, who shared the lead with another American for most kills in a P-47 with 28, experienced perhaps better than any other flyer the T-bolt's durability. After a particularly harrowing air battle, the wounded Johnson made a forced landing behind Allied lines to find that his stout "Jug" had sustained 21 hits by 20mm cannon and more than 100 rounds of machine gun fire.

Specifications: *Type:* Single seat fighter-bomber; *Power plant:* One 2,300 Pratt & Whitney R-2800 Double Wasp 18-cylinder two-row radial; *Wingspan:* 40.8 ft; *Length:* 36.1 ft; *Height:* 14.2 ft; *Weight:* 19,400 lbs; *Maximum Speed:* 428 mph; *Climb:* 2,800 ft/min; *Ceiling:* 43,000 ft; *Range:* 590 miles; *Armament:* Eight 0.50 in Colt-Browning M-2 machine-guns in wings.



*The P-47 was a match for the German fighters. Above 20,000 feet it was actually faster than the 109 and 190, but it always suffered somewhat in maneuverability. One of its main assets was its armor. The P-47 could take a hell of a beating and continue flying.*



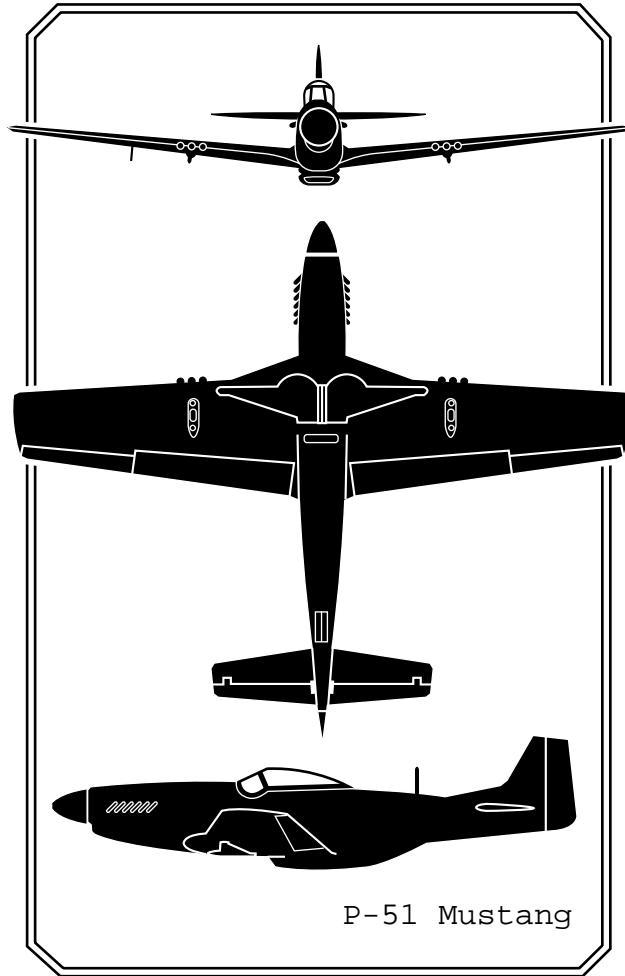

P-51 Mustang

## NORTH AMERICAN P-51D MUSTANG

Without a doubt the most famous fighter plane of World War II, the P-51 Mustang was originally rejected by the USAAF. It was designed and built as a ground attack aircraft for the RAF. North American's president promised the British a fighter superior to the P-40, in spite of its being powered by the same engine. And he was able to deliver on that promise because of the P-51's revolutionary new airframe. On its first test flight the Mustang exceeded the top speed of the P-40 by a full 25 mph. The RAF got its first P-51s in November of 1941, but before North American could go ahead and sell them to the British the USAAF wanted to take a look at them. But after extensive testing by experienced combat pilots (who unanimously favored the new fighter), the USAAF for some reason did not place an order.

The Mustang's one shortcoming lay in its Allison motor, which performed poorly at medium to high altitudes, where most air-combat took place. For this reason, the RAF outfitted its first Mustangs with cameras and used them for reconnaissance. Realizing that the superior airframe of the Mustang was being cheated of its full potential by a sub-standard motor, in November of 1942 the RAF sent five of them to Rolls-Royce to be outfitted with the best Merlin supercharged engines. Predictable as the result might have been, it astonished pilots and engineers alike. The marriage had produced a plane at least 50 mph faster (440 mph), with a much swifter rate of climb and a substantially greater range. Equipped with drop-tanks, the P-51D could traverse up to 2,300 miles, making it ideal for long range escort. Its six .50 calibre machine guns made it both a formidable opponent in the air, and an effective troop and airfield strafing. Also, the Mustang could carry 2000 lbs. in bombs, and it was occasionally called upon to do so. Mainly, though, the P-51 Mustang was an awesome fighter. In the course of its service in Europe, Mustang pilots destroyed nearly 9,100 enemy aircraft both in the air and on the ground—a full 49 percent of all his lost aircraft, not to mention the some 230 V-1 “buzz-bombs” it shot down. So fast and agile was the fighter that it even notched several victories over Germany's first jet-aircraft. After the war, the Mustang saw duty in Korea, where it performed well until the MiGs showed up.

Specifications: *Type:* Single-seat fighter; *Power plant:* One 1,590 hp Packard-built Rolls-Royce Merlin V-1650-7 liquid-cooled engine; *Wingspan:* 37.0 ft; *Length:* 32.2 ft; *Height:* 13.7 ft; *Weight:* 7,125 lbs; *Maximum Speed:* 437 mph; *Climb:* 3,475 ft/min; *Ceiling:* 41,900 ft; *Range:* 950 to 2,000 miles; *Armament:* Six Browning MG53-2 machine-guns in wings.



*The P-51 was the best American fighter in the war, equal to anything the Germans put up against her. With her two-thousand mile range, she turned the air war against Germany by protecting our bombers over the deepest targets. Her two-stage, two-speed supercharger provides terrific speed and maneuvering performance — a dogfighter's dream. Loaded with fuel and ammo, the P-51 was a tricky plane to fly, and also vulnerable. Get hit in your radiator and lose your coolant, and you're going down.*

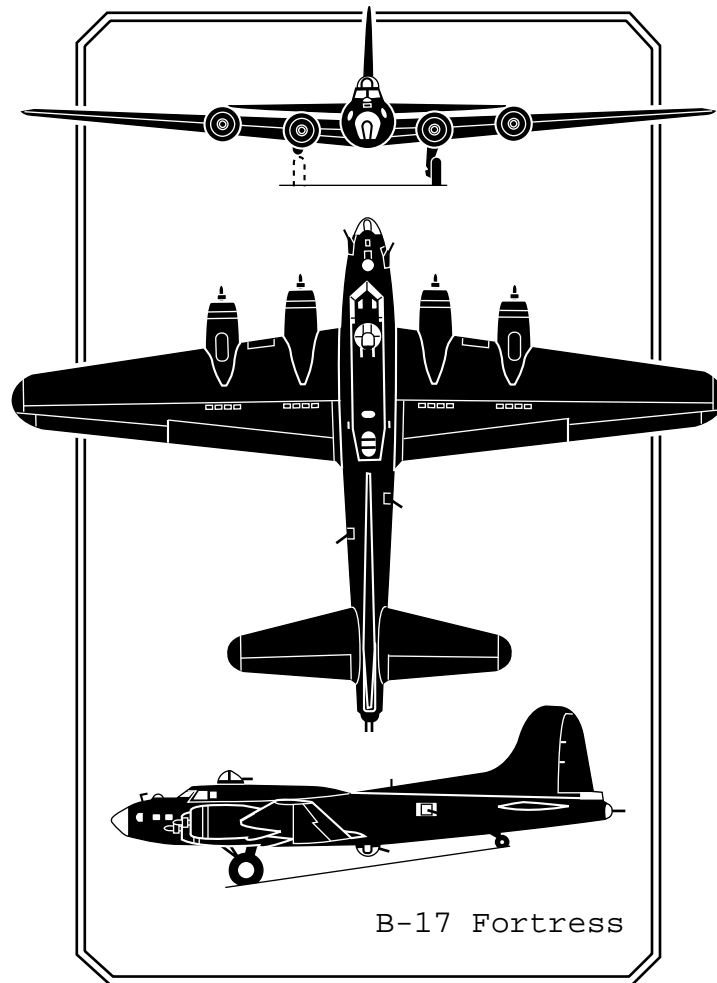

B-17 Fortress

## BOEING B-17E FLYING FORTRESS

Originating as a private venture by Boeing, the B-17 got off to a shaky start when the prototype crashed on takeoff in military trials. But evidence showed that human error was to blame, and the USAAC placed a small order in 1936. The first B-17 powered by a turbocharged engine was the B-17B, 39 of which the USAAC took delivery in 1938. As war grew imminent in Europe, the RAF ordered 20 versions of the subsequent B-17C, which they tested and helped improve. The next two models had better armored and self-sealing gas tanks.

It was the B-17E that most befitted the appellation "flying fortress". It carried one .30 in. and 12 .50 in. guns positioned from chin to tail and up to 17,600 lbs of bombs. Despite its heavily armored airframe and wealth of defensive weaponry, the B-17E suffered severe losses against the Luftwaffe fighters over Germany, where it bore the brunt of U.S. daylight bombing missions. Numerous variations on the Flying Fortress cropped up, including transports, air-sea rescue aircraft, even pilotless, radio-controlled bombers. In all, more than 12,700 B-17s were built.

Specifications: *Type:* High altitude bomber; *Power Plant:* Four 1,200 hp Wright R-1820-97 Cyclone nine-cylinder radials with exhaust driven turbochargers. *Wingspan:* 103.8 ft; *Length:* 73.8 ft; *Height:* 19.1 ft; *Weight:* 31,150 lbs (loaded); *Maximum Speed:* 317 mph; *Ceiling:* 35,000 ft; *Range:* 1,100 miles; *Armament:* 13 0.50 machine-guns and 17,600 lbs in bombs.

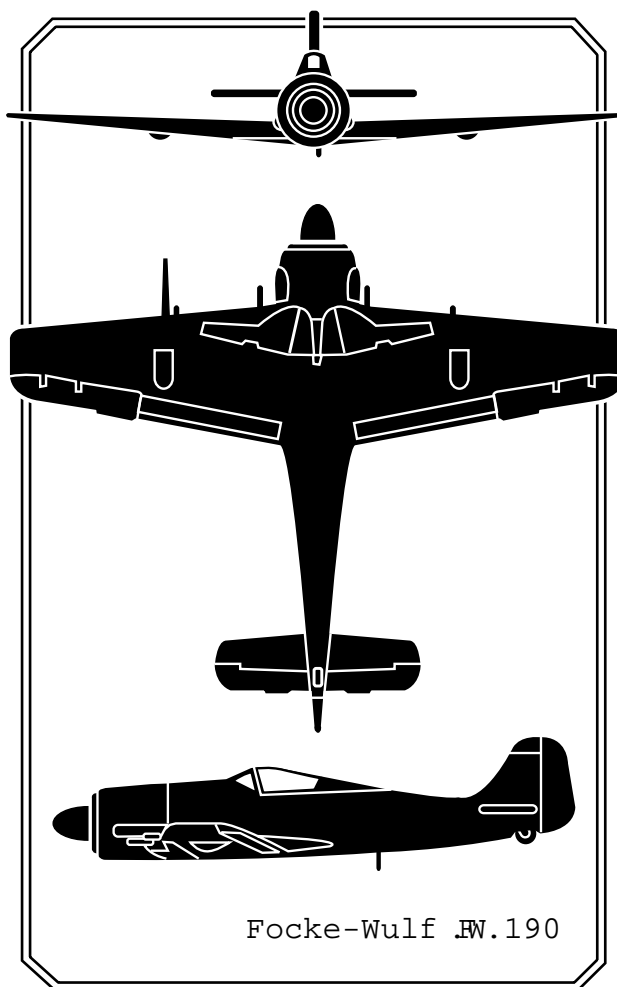

Focke-Wulf FW.190

## FOCKE-WULF FW-190A-8

Patterned after the Hughes racer which had broken the air-speed record in the U.S., the FW-190 was a marvel in compact design. The bulky but reliable air-cooled radial engine posed a challenge to engineers, whose task it was to reduce drag and increase maneuverability; and the engineer, Kurt Tank, succeeded admirably. What he and his team came up with was a very small, light-weight, all-metal fighter-bomber capable of carrying heavy armament. Indeed, it was the most heavily armed single-engined fighter of its day. Although the first 190s were in service before the war began, the RAF knew not of their presence. Their first appearance in the air-war over France in 1941 caused a great deal of alarm to the Allies. Not only was the FW-190 a far superior fighter to the Spitfire V, but it out-numbered her as well. Curiously, it never supplanted the Me-109, which it was designed to replace.

Not until the Mustang arrived on the scene did the Allies have an effective counter to the FW-190A, versions of which first appeared in June, 1941. The last version of the A-series, the 190A-8, was produced in greater numbers than any of the previous sub-types and modified to accommodate a power-booster, which could be used for ten minutes at a time at five minute intervals. The only mentionable drawback of the A-8 was its relatively poor handling at high altitudes, and for this reason it served mostly as a ground-attack aircraft. Of all the Luftwaffe's different weapons, the FW-190 in its dozens of versions had the greatest utility. It was adapted to long-range missions, to fire anti-ship weapons and 21 cm. mortars, and to a dozen other purposes. There was even a ramming sub-type outfitted with armored leading edges. Arguably, it represented the crowning achievement of German aerial combat technology.

Specifications: *Type:* Single-seat fighter-bomber; *Power Plant:* One 1,700 hp BMW 801 Dg 18-cylinder two-row radial engine; *Wingspan:* 34.5 ft; *Length:* 29.0 ft; *Height:* 13.0 ft; *Weight:* 7,055 lbs; *Maximum Speed:* 408 mph; *Climb:* 2,350 ft/min; *Ceiling:* 37,400 ft; *Range:* 497 miles; *Armament:* Two 13mm MG 131 machine-guns above engine, four 20mm MG 151/20 cannon in wings.



*After the war, I flew a 190 at Wright Field. Out of all the Japanese and German fighters, it was the only thing close to a Mustang. But it certainly gave the RAF a scare when they first encountered it over France. The British had to wait for the Mark IX Spitfire before they felt like they could go toe-to-toe with the 190. By the time I got there, the USAAF was using Mustangs and we knew we were on a par with the Germans.*



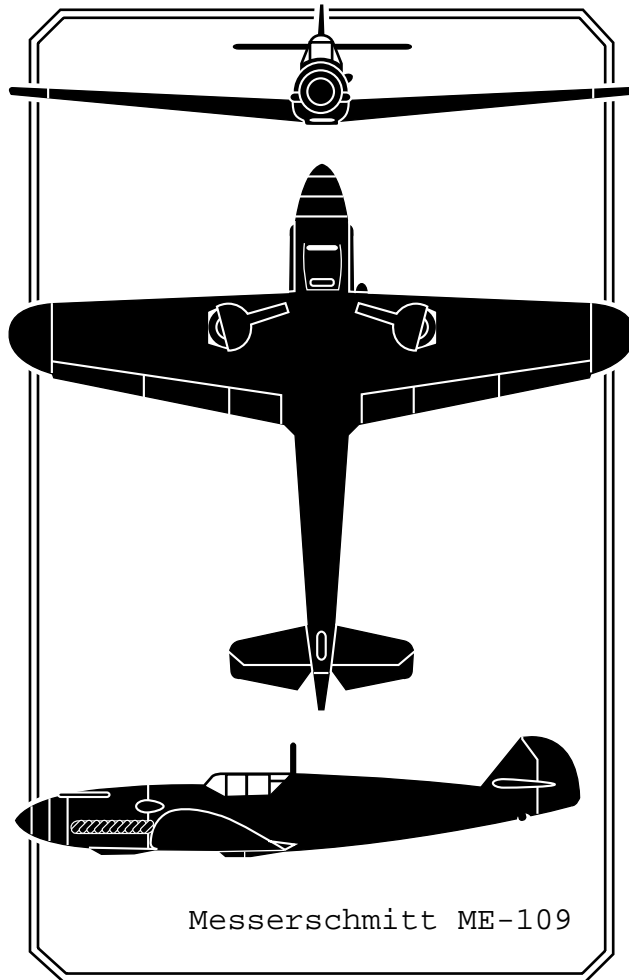

## MESSERSCHMITT ME-109E EMIL

By far the most important fighter in the Luftwaffe's potent arsenal, the first Me-109 came off the line in 1935 and subsequently developed during operations in the Spanish Civil War, where 109s dominated the air. Perhaps the most advanced aircraft of its day, the Me-109 was one of the first low-wing monoplanes. The definitive 109E was ready in great numbers by the time Germany invaded Poland, and time and time again it showed its superiority over all of its opponents, save the Spitfire. Differing only slightly from the 109D series in its general design, the 109E enjoyed a fuel-injected power plant, which improved its performance greatly. As g-forces became greater, fuel-flow to the motor became more and more of a concern for pilots engaged in dogfights. Naturally, fuel-injection eliminated that problem.

An outstanding fighter in its own right, the Me-109 occasionally carried bombs. Along with two 8 mm machine guns on the engine crankcase and one formidable 20 mm cannon firing through the airscrew hub, it could be made to deliver 1000 lbs. worth of payload if need be. But it was used mainly as a fighter, and occasionally as an escort. However, as an escort for slower bombers it ran into trouble. The 109's greatest virtue was its maneuverability at high speeds, in the 350 mph range. At slower speeds other fighters, such as the Spitfire and the Hurricane, could out-turn it; so in a sense it was too fast to be a reliable escort. By mid-1941, the Luftwaffe was beginning to phase out the Me-109E, though it would see service in Japan the following year.

Specifications: *Type:* Single seat fighter/fighter-bomber; *Power Plant:* One 1,300 hp Daimler-Benz DB 601E inverted-V-12 liquid-cooled engine; *Wingspan:* 32.4 ft; *Length:* 28.3 ft; *Height:* 7.5 ft; *Weight:* 4,330 lbs; *Maximum Speed:* 390 mph; *Climb:* 3,100 ft/min; *Ceiling:* 38,000 ft; *Range:* 350 miles; *Armament:* Two 8mm cannon MG-17 machine-guns above engine, one 20mm MG-151 cannon in propellor hub.



*In the early part of the war, the 109 was a formidable machine, especially in the hands of Germany's aces, all of who'd gotten experience in Spain and Poland. Fortunately for the British, the Spitfire was equal to the 109.*

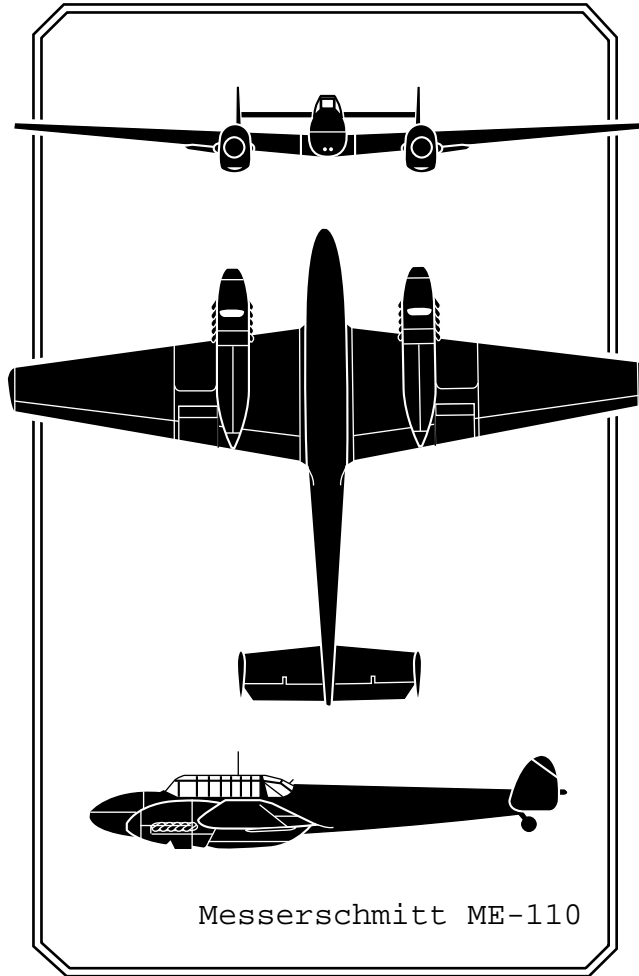

Messerschmitt ME-110

## MESSERSCHMITT ME-110B ZERSTORER

The Me-110 represented the best of many mostly unsuccessful attempts by various nations to answer the need for a long-range escort fighter capable of battling the smaller, single-seaters. The intention behind the Me 110 was to build a fast, heavily armed two- or three-seater that made up in firepower what it lost in maneuverability. The concept might have been sound, but no plane including the Me-110 fulfilled the theory's promise. A pilot coming up against an Me-110B had to contend with two 20 mm. nose-mounted cannons, four 8 mm nose-mounted machine guns, and one of the same in the rear of the cockpit.

Until the Battle of Britain the Me-110 made a good accounting of itself, but when it came up against Hurricane and especially the Spitfire its woeful inadequacies became immediately apparent. Before long Me-109s had to escort the Me-110s which in turn escorted the bombers. Such a ridiculous state of affairs pointed up both the 110s shortcomings and the Luftwaffe's growing disorganization and ineptitude. The one area in which the Me-110B cannot be justly maligned was in its role as a night-fighter. Its powerful weaponry wreaked destruction on countless Allied bombers when their escorts were least effective.

Specifications: *Type:* Two-seat/three-seat fighter; *Power Plant:* One 1,100 hp Daimler-Benz DB 601A engine; *Wingspan:* 32.4 ft; *Length:* 28.3 ft; *Height:* 7.5 ft; *Weight:* 4,330 lbs; *Maximum Speed:* 349 mph; *Climb:* 2,255 ft. min; *Ceiling:* 32,800 ft; *Range:* 559 miles; *Armament:* Two 20mm Oerlikon MG FF cannon in nose, four 7.92 mm MG-17 machine-guns in nose, one 7.92mm MG-17 manned machine-gun in rear cockpit.



*Before World War II, lots of countries tried to produce long-range escort fighters. The Me-110 was one attempt, but the Germans found out that it just couldn't perform like the single-seat British and American fighters. They actually had to fly escorts for the 110s, if you can imagine. It did well as a night fighter, though.*

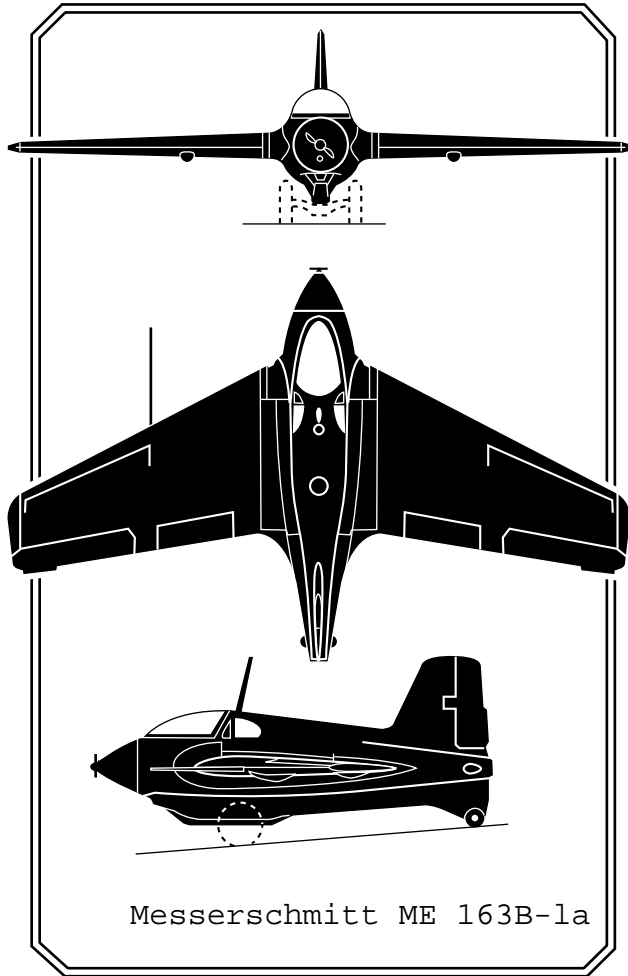

Messerschmitt ME 163B-1a

## MESSERSCHMITT ME-163 KOMET

The Me-163 was the strangest aircraft to see action in WW II. Its fuselage short and squat, its wings swept back, without a horizontal tail-wing, the Komet was powered by two rocket propellants which ignited when they came into contact. Both in appearance and in operation, its technology was futuristic, even bizarre. In the highly competitive scientific environment of the time, it is still no wonder that neither France, England, nor the U.S. attempted to develop anything even remotely similar to the Me-163's engine or airframe. The Komet's radical design notwithstanding, the idea of having a short-range, rocket-powered interceptor was quite sound, and the Allies were lucky that the Komet had as many problems as it did.

The Me 163's biggest problem was in landing. Having no landing gear, the pilots had to land on a skid and, if the aircraft bumped or bounced too much, left-over propellants were liable to slosh together and ignite the plane. In the air, however, the Komet performed marvelously well and in 1944 took a grievous toll on Allied bombers with its two 30 mm cannons. Still, because of frequent accidents related almost exclusively to the propellants, attrition dwindled its numbers. A mere 370 Me-163s actually saw action and of these only a few were shot down. Its great speed, which averaged close to 600 mph, made killing it almost impossible. The rest either exploded while landing or were mercifully put out to pasture.

Specifications: *Type:* Short-range fighter-interceptor; *Power Plant:* One 16,67 kN 3,748 lb thrust Walter 109-509A-2 rocket motor; *Wingspan:* 30.6 ft; *Length:* 18.6 ft; *Height:* 9.0 ft; *Weight:* 4,191 lbs; *Maximum Speed:* 596 mph; *Climb:* 16,400 ft/min; *Ceiling:* 54,000; *Range:* 50 miles; *Armament:* Two 30mm MK 108 cannons, twenty-four rockets underwing, to vertically discharged rockets within the wing.



*The Me-163 was a stable enough aircraft while gliding. It was the damn engines that were truly lethal. The propellants the Germans used were awfully dangerous, and with no landing gear — you were expected to skid the thing to a halt — a lot of pilots just died flying the thing.*



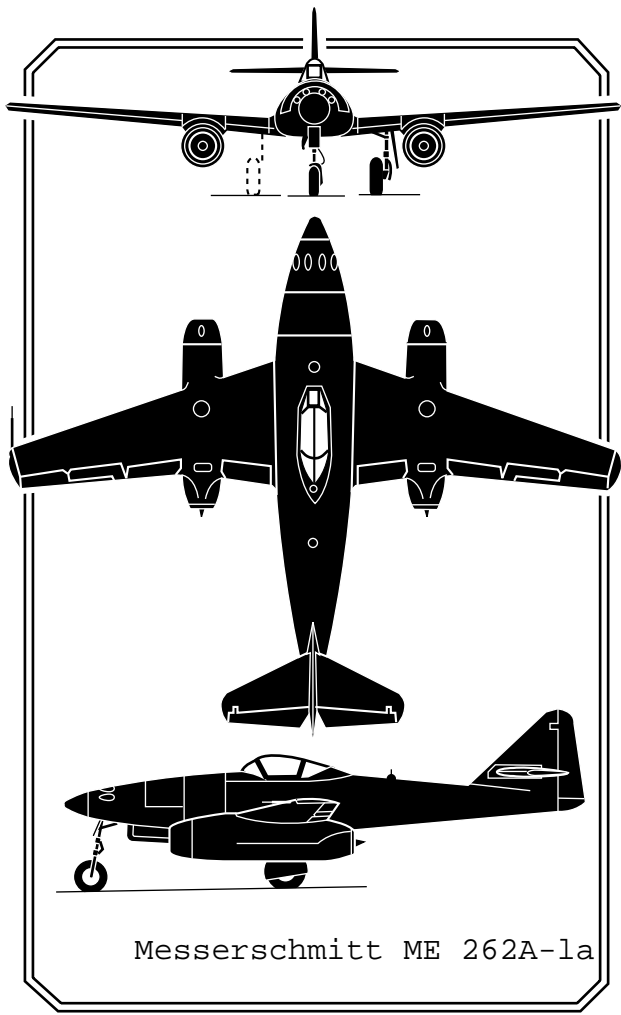

Messerschmitt ME 262A-1a

## MESSERSCHMITT ME-262 STURMVOGEL

Another example of bureaucratic interference and delinquency on the part of the German High Command came in its treatment of the Me-262. Hitler was obsessed with the idea of having the supreme, jet-powered bomber, when what he really needed was a fighter that could deal effectively with the myriad Allied bombers visiting daily devastation on Germany's industrial complex. Had the Sturmvogel been introduced in time and in sufficient numbers, it could well have re-taken the skies over Germany and helped to prolong the war.

While Hitler undoubtedly wasted precious time insisting that the Me-262 be developed as a bomber, there were other problems which held it back, particularly in the development of a reliable turbojet engine. The project began in 1938, but the first flight-cleared turbojets did not arrive until the November, 1941, and even these proved faulty. In spite of the technological problems and a certain amount of apparent official indifference, which might have actually been political overcaution, in 1944 the Sturmvogel without a doubt succeeded in being the first turbojet warplane to engage enemy aircraft. But by then it was too late to make much of a difference. Its virtues were simple: superior speed and powerful armament. As an interceptor it was unparalleled. Indeed, it marked the beginning of a new age in aircraft. Fast enough at better than 540 mph to obviate the need for dogfighting, it carried four 30 mm cannons in its nose which packed enough wallop to down the stoutest Allied bombers. Only 100 or so actually saw operations, and of these only a handful were shot down, while the rest sent down far more than 100 opposing aircraft.

Specifications: *Type:* Single-seat fighter; *Power Plant:* Two 1,980 lb thrust Junker Jumo 004B single-shaft axial turbojets; *Wingspan:* 41.0 ft; *Length:* 34.8 ft; *Height:* 12.6 ft; *Weight:* 8,820 lbs; *Maximum Speed:* 540 mph; *Climb:* 3,940 ft/min; *Ceiling:* 37,565 ft; *Range:* 652 miles; *Armament:* Four 30mm MK 108 cannon in wings.



*The jets had a 150 mph speed advantage over the Mustang, but their pilots tried to avoid dogfights, concentrating instead on hammering the bombers. Rarely did we encounter any jets. The word on them was that they were wing-heavy; the Mustang, with its laminar flow wing, could easily turn and dive with them, but in a level chase there was no contest; the Me-262 just sped out of gun range.*

*After the war, I was an Air Force test pilot and I asked to do a comparison between the P-80 Shooting Star — the jet we had been developing during the war — and the Me-262. I was fascinated to discover that the 262 and the Shooting Star performed identically — the same range, top speed, acceleration, and rate of climb.*

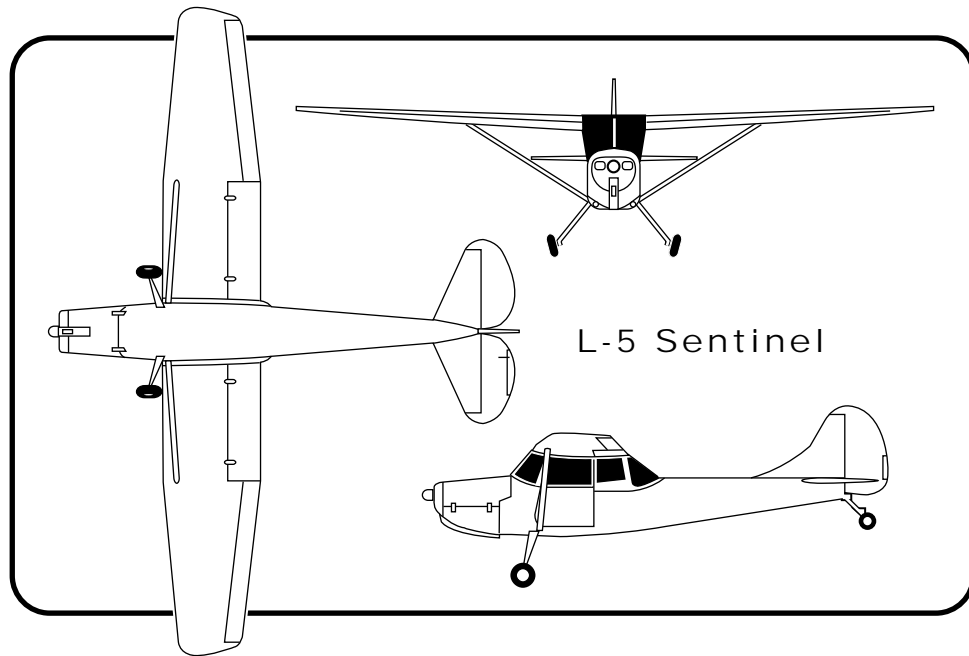

#### STINSON L-5 SENTINEL

The L-5 Sentinel was a tiny, two-seater, liaison and communications aircraft, sometimes outfitted to carry a stretcher. It had no weaponry, a very short range, and could transport no more than 200 lbs. The RAF took delivery of 3,000 Sentinels during WW II under the provisions of Lend-Lease, using many of the aircraft in the Burmese theater.

Specifications: *Type:* Two-seat short-range aircraft; *Power Plant:* One 141.6 kW 190 hp Lycoming O-435-1 engine; *Wingspan:* 34.0 ft; *Length:* 24.1 ft; *Weight:* 2,158 lbs; *Maximum Speed:* 129 mph.

## AIR SUPERIORITY OVER KOREA

At the end of WW II, the Korean people fervently believed that they were about to escape from years of Japanese domination and achieve political independence. But their hopes were not to be realized. First, the administration of the Japanese withdrawal from Korea became the subject of a dispute between Russia and the United States. The two superpowers were determined to act as trustee for the newly emancipated nation until a proper government could be set up. Finally, the White House and the Kremlin agreed to temporarily divide Korea along the 38th Parallel. The Soviets would help administer the northern half, while the Americans would chaperone the southern, which included the capital, Seoul.

Tensions began to build almost immediately. Rival governments were set up in 1948, the South declaring itself the Republic of Korea, the North calling itself the People's Democratic Republic of Korea. It seemed that no Koreans liked the idea of the "trusteeships." Both North and South wanted a unified Korea, a single national entity. But neither side would capitulate to or compromise with the other's political system.

Over time both sides grew more entrenched in their positions and communication between the two all but ceased. Hostilities erupted on June 26, 1950, when Communist forces crossed the 38th parallel, attempting to unify the country by military force. U.S. President Truman called upon the United Nations Security Council for a resolution condemning the aggression and authorizing the use of force to expel the invaders. Truman received the endorsement, and troops from fifteen other U.N. members committed themselves to defend South Korea.

The war went poorly for the South Koreans during the first few months of fighting. North Korean forces met little resistance as they drove South and they dominated easily. But on September 15 the U.N. forces launched a daring counteroffensive driving the North Korean forces back across the 38th parallel. One month later the North Korean forces had their backs to the Yalu River, which forms the border between North Korea and China. Chinese Communists then joined the fight, helping the North Koreans to drive back the U.N. forces. After another year of hard but indecisive fighting, the two sides regrouped on their respective sides of the 38th parallel. No further progress was made by either side.

With superior air-power, the North Koreans most probably would have succeeded in driving the South Korean and supporting U.N. forces into the Sea of Japan. But as soon as the U.S. began to deploy sufficient aircraft, the tide shifted. Indeed, before China joined with the North Koreans, American bombers flew virtually unchallenged.

The only real threat to U.S. air superiority came when the Chinese sent in their Russian-built MiG-15. Prior to the entrance of China into the war, the U.S. relied on an assortment of propeller driven planes along with three species of first-generation jets to maintain air superiority over North Korea's strictly piston-driven air force. On October 19 a flight of Mustangs encountered six MiG-15s over the Yalu River, in a section that would later become known to pilots as "MiG Alley." The astonishing speed and revolutionary design of the unexpected MiGs dismayed the Mustang pilots who, in spite of their disadvantage, escaped unhurt from the initial encounter. The North Korean pilots, it seemed, were not very skillful.

In order to challenge the MiGs the U.S. brought in the F-86 Sabres which, though comparable to its Russian foe in general design, was much heavier and therefore a much slower climber. In addition to its distinct superiority as a fighter jet, the MiG-15 also carried heavier armament than the F-86, in the form of 3 cannons. Sabres bore conventional, W.W. II type machine guns, and occasionally wing-mounted rockets. But with all of their advantages, the MiG-15 pilots could not match the skill and experience of the American flyers. By war's end American and U.N. flyers claimed roughly 800 MiGs to a loss of only fifty-eight Sabres. The wide disparity in the relative skill of a typical pilot from either side is illustrated by the fact that, in the first jet-to-jet dogfight in history, a MiG-15 fell to the far inferior F-80 Shooting Star.

Most of the Sabre vs. MiG-15 dogfighting took place in MiG Alley over the Yalu River. The MiGs were based on

airfields on the Chinese side of the river, over which U.N. aircraft were forbidden to cross. MiG pilots, wary of their superior enemy, seldom came up to meet the Sabres which taunted them from above, sometimes violating just a sliver of Chinese air-space. Using their higher service ceiling, MiG pilots occasionally tried to lure Sabres into a snare. Two MiGs fly as decoys below the Sabres while another pair waited up-sun, ready to pounce as soon as the Sabres assumed an attacking posture.

In one regard the Korean war marked the beginning of a new epoch in aerial combat. For the first time in history jets went up against jets. But their armaments were not vastly updated, and in that respect the Korean War marks the end of an old era. Gone were the ham-fisted flyers of yesteryear, for the planes were now so responsive that sometimes they seemed controlled by thought alone. However, while the planes were of a new age, weapons systems had yet to catch up. A pilot's skill in targeting and firing still had more to do with his sheer talent than it did with precision technology. In Vietnam we will see a contest of avionics and missile guidance systems.

### MAY 20, 1952

America's first jet ace, Capt. James A Jabara, like many of the American fighter-pilots in the Korean War, was a veteran of World War II, where he chalked up 3 1/2 kills in his P51-Mustang. Jabara arrived in Korea in the spring of 1952 with the 334th Fighter-Interceptor Squadron, and in his first month he shot down four MiGs, establishing himself as an exceptional combat pilot. But his second month in Korea yielded scarcely a sighting. Understandably, the inexperienced and overmatched North Korean airmen had grown timid. As the time for his squadron to rotate back to Japan drew near, an eager Jabara transferred to the 335th, the squadron scheduled to replace the 334th.

For nearly a month in his new squadron, Jabara's fifth kill eluded him. He began to think that he would finish his tour still one kill short of ace-hood, for he was close to completing his 100th mission, the end of the line for a pilot. But on the 20th of May, Jabara's fortunes changed. At 5 AM a call came in to the squadron room. Some fifty MiGs had jumped fourteen F-86 Sabres over the Yalu River, in a section known as MiG Alley. Jabara and thirteen fellow pilots sprinted to their jets and took to the air.

Approaching MiG Alley, Jabara saw more MiGs than he could count and, pressing the button to release his drop tanks, he prepared for battle. One tank failed to drop off, and the Sabre pitched to one side. The pilots had a standing order: in the event of a "hung tank", return to base immediately. Hungering for his long awaited fifth kill, Jabara ignored the order and announced to his wingman that they were going to fight. Compensating with his rudder for the unwanted ballast, Jabara dove in behind a formation of three MiGs and drew a bead on one, but as he was about to fire his cannons three more MiGs swooped down from the rear. Tracers whizzed across his canopy as Jabara turned in on his attackers. Having overshot their target, two nervous Communists broke off immediately, leaving their comrade to fend for himself. A superior flyer, Jabara latched on to the third pilot and bore in. The hapless North Korean tried every evasive maneuver he knew, but to no avail. Jabara hit the MiG with three bursts and watched as the jet caught fire, snap-rolling violently, and fell into a spin. The pilot ejected moments before his MiG exploded into a ball of fire. James Jabara was now the first jet-ace in history.

But he was not ready to call it a day, not with ample fuel in his tanks and the battle still raging above him. Jabara climbed back up to 20,000 feet and engage the first MiG he spotted. His first shot tore into the shiny aluminum fuselage, and his second ignited it. As Jabara paused to admire his flaming handiwork, a MiG appeared on his tail. Self-indulgence can cost a fighter pilot his life, and Jabara almost lent further validation to that axiom. He dove, rolled, climbed—did all he could to shake his pursuer—but the MiG hung on. Had two vigilant Sabre pilots not shown up to drive the MiG off, Jabara might have joined the two men he had just dispatched. He admitted as much afterwards, saying he'd been "in big trouble."

Two weeks later, Jabara found himself back in the States with six kills to his credit and his place in history secure. But in January of 1953, out of action for more than a year and a half, he re-enlisted, adding nine kills to his total by war's end, only one behind James McConnel, the Korean War's leading ace.

## AIRPLANE DESCRIPTIONS

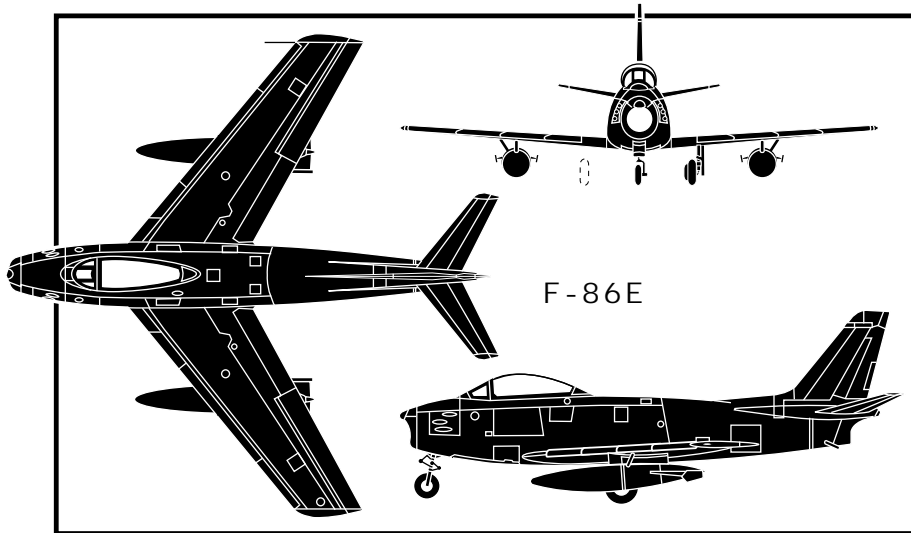

## NORTH AMERICAN F-86E SABRE

America's first swept-wing jet, the F-86 Sabre, grew out of German research discovered in documents in occupied Germany after the war. Further tests conducted in the U.S. showed that an airplane with its wings swept back 35 degrees handled much better at high speeds than a straight-winged plane. In a test flight of an XP-86 on April 26, 1948, pilot George Welch broke the sound barrier. With a fuselage constructed entirely of metal, the F-86 Sabre came equipped with ejector seat, hydraulic ailerons, and self-adjusting leading edge slats. Its nose opened into a wide air intake, and air brakes were positioned on either side of the rear fuselage. Its record-breaking speed was unparalleled.

There were two main variants of the F-86: fighter-bombers (this includes F-86Es) and all-weather interceptors. It carried six .50 calibre machine guns and either 2,000 lbs of ordnance or 16 rockets, giving it more destructive power than any airplane in its class. All the different Sabres combined accounted for nearly 800 MiG kills, allegedly suffering a mere 78 losses. Whatever the actual kill ratio, and it was certainly at least 4:1, the fact remains that all American aces in the Korean war were Sabre pilots. That alone is sufficient testimony to its superiority in that theater. After the war the Royal Canadian Air Force purchased the license to build 1,815 F-86Es, and within a few years at least 26 different countries, including Germany's Luftwaffe, were using either American-built Sabres or licensed copies. Nearly 8,700 were built, a record soon topped by the Phantom.

Specifications: *Type:* Single-seat interceptor-fighter; *Power plant:* One 5,200 lb thrust General Electric J-47-13 turbojet; *Wingspan:* 37.0 ft; *Length:* 37.0 ft; *Height:* 14.0 ft; *Weight:* 10,555 lbs; *Maximum Speed:* 679 mph; *Climb:* 4,760 ft/min; *Ceiling:* 47,000 ft; *Range:* 925 miles; *Armament:* Six 0.50 in machine guns.

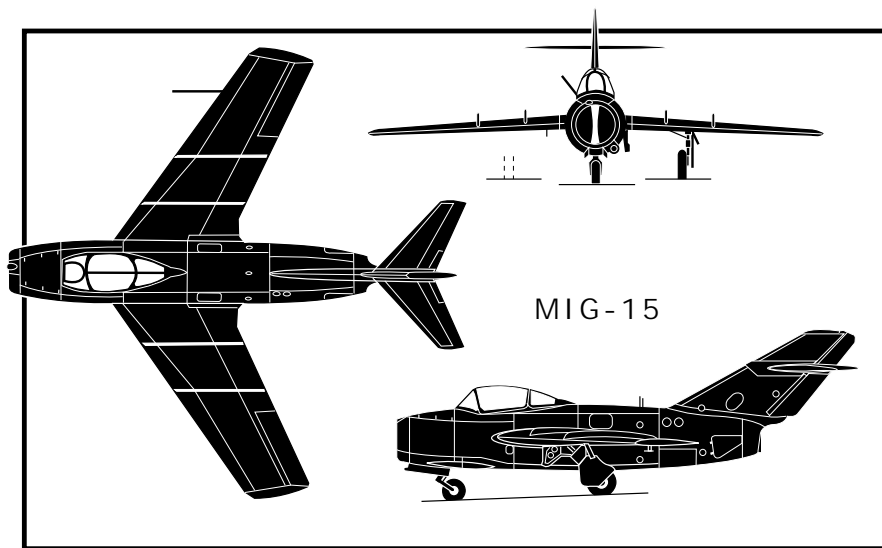

#### MIKOYAN-GUREVICH MIG-15 FAGOT

No other combat aircraft has altered the military climate of its day more than the MiG-15 did when it showed up in North Korean airspace to counter unsuspecting American airmen. Indeed it was a well-kept secret, so much so that when it arrived in North Korea, America's F-86 Sabre, the only fighter in its league, lay quiet on the U.S. mainland. That it resembled the Sabre in its general design was no coincidence; both designs had their roots in the same German aeronautical studies captured at the end of WW II. But the greatest boon to the Mikoyan-Gurevich bureau was England's decision to export the latest Rolls-Royce turbojet engine to the Soviet Union. The Soviets promptly copied the engine and fitted it to their revolutionary swept-wing fighter.

The MiG-15's first known flight took place in December of 1947, and mass production of the jet commenced soon thereafter. The "Fagot", as it was designated by NATO, flew its first combat mission in 1951 over North Korea, driving out a host of inferior enemy aircraft. The MiG-15's level speed, rate-of-climb, service ceiling, and maneuverability made it an almost invincible weapons platform, and for punch it packed one 37mm cannon, and two 23mm cannons, all under its nose. Were it not for the F-86 Sabre and her experienced flyers, the Korean War would certainly have lasted longer or had a different outcome. For all its superior high-altitude performance, the MiG-15 suffered from a lack of avionics. The inexperienced North Korean pilots were largely limited to what they could see and what they were told over their radios, which put them at a great disadvantage when facing Sabres, which carried the most sophisticated avionics of their day, and whose pilots were superior to begin with. Also, at Mach 0.9 and above, the Fagot had a tendency to pitch and snake about.

Specifications: *Type:* Single-seat fighter; *Power Plant:* One 5,005 lb thrust RD-45 Rolls-Royce Nene turbojet; *Wingspan:* 33.1 ft; *Length:* 36.3 ft; *Height:* 11.1 ft; *Weight:* 8,820 lbs; *Maximum Speed:* 668 mph; *Climb:* 10,500 ft/min; *Ceiling:* 51,000 ft; *Range:* 1,115 miles; *Armament:* One 37mm NS-37 cannon in nose, two 23mm NS-23 cannons in nose.



*In February of 1954, a Korean pilot named Kim Sok Ho defected to the west with a MiG-15. I was one of the first to try it out. It had problems — oscillating, pitching up unexpectedly, fatal spins, lousy pressurization, and a problem with the emergency fuel pump: turn it on and it could blow the rear of the airplane. It couldn't ever go above Mach .93 because it didn't have a flying tail on it. It was lighter than the F-86 so it could accelerate a little faster, but it had a lower top speed and it could get to a higher altitude. Here again, it had a very critical turning capability. I mean, you couldn't turn it at its maximum rate of turn because it didn't have any stall warning — it'd snap out on you and get into a spin and you couldn't get out.*



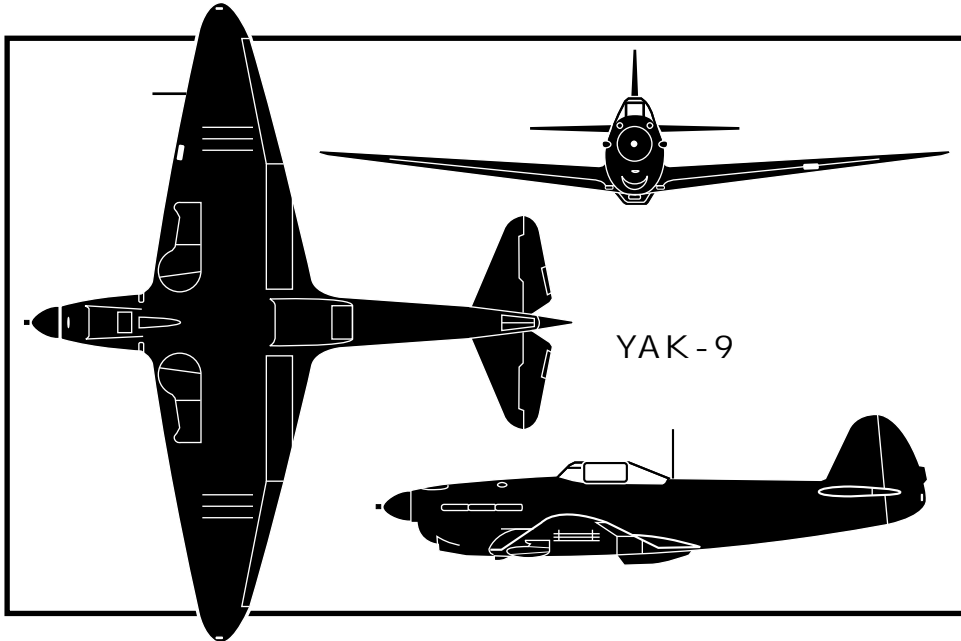

## YAKOVLEV YAK-9

The early Yak fighter, though never fully-deployed in WW II, ranks with the Me-109, the FW-190, the P-51 Mustang, the Supermarine Spitfire, and the Mitsubishi Zero, as a superior combat aircraft of its day. Evidence of its potential came most vividly in its sound though limited performance at the Battle of Stalingrad. It would have made a greater impact had Germany not invaded Russia in the early stages of its production. Resources were already scarce in Russia, and the Yak factories lay in the west, where they could not be adequately defended against the German advance. By the time Russia could move Yak production to the East, the war was nearly over.

Unique in their construction, the early Yaks were made of wood, steel, light alloy, and fabric. Improvements in design were necessarily slow, or ignored, given the scarcity of raw materials and the need for rapid manufacture. But the Yak-9 exhibited a marked evolution from its forerunners, particularly in its replacement of metal wing-spars for wood, thereby allowing a greater fuel-capacity in the wing, hence greater range.

Due to wartime conditions, armaments on Yaks varied greatly. Most of the Yak-9s supported small, engine-mounted cannons and two fuselage-mounted 7.62 mm machine-guns. One version of the Yak-9 was outfitted with bombs, a testament to the design's over-all versatility. In all more than 17,000 Yak-9s were built, many of which saw service in the Korean War where they were mostly ineffective against the improved technology of the thriving industrial West.

Specifications: *Type:* Single-seat fighter; *Power Plant:* One 1,014 kW 1360 hp Klimov Mi-105P f-3 engine; *Wingspan:* 32.8 ft; *Length:* 28.0 ft; *Height:* 8.8 ft; *Weight:* 7,055 lbs; *Maximum Speed:* 368 mph; *Climb:* 2,400 ft/min; *Ceiling:* 32,800 ft; *Range:* 875 miles; *Armament:* One 20mm cannon, one 12.7mm machine-gun.

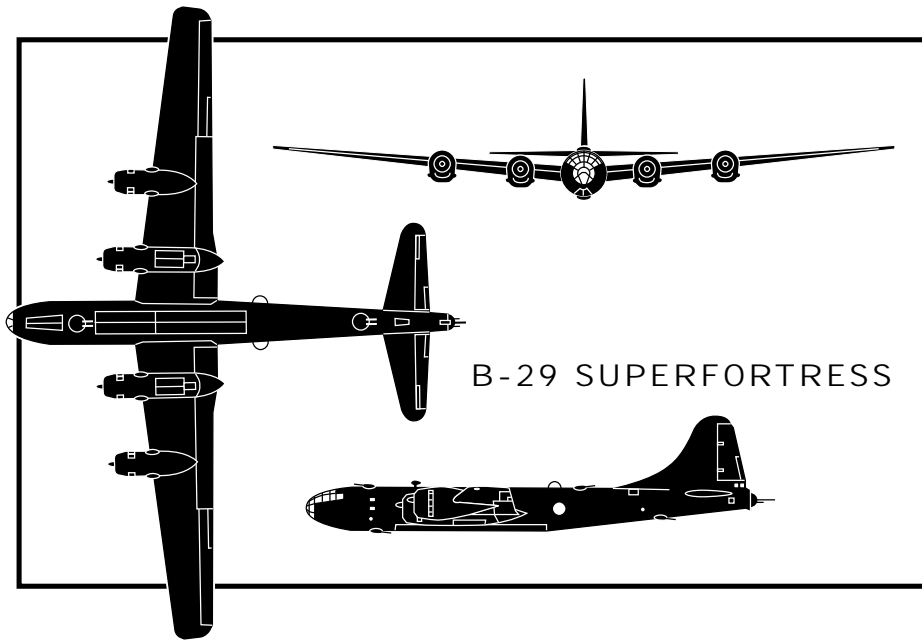

## BOEING B-29C SUPERFORTRESS

The B-29 grew out of a proposal to Boeing by the USAAC to improve the B-17. What the military wanted was high-flying, long-range bomber able to deliver a massive payload, but at the time (1938) they were not authorized to place an order or even to guarantee funds. Boeing went ahead with a plan regardless so that in 1940, when the newly re-named USAF officially invited U.S. aircraft manufacturers to submit proposals for a new long-range bomber, Boeing was well ahead of the game. Later in the same year, the Air Force ordered three prototypes.

Among the advances incorporated into the Superfortress' design were pressurized compartments for all fourteen crew members, including the tail-gunner. Earlier models of the B-29 bore up to eleven guns in five turrets, but the B-29C defended itself with one 20mm cannon and one .50 caliber machine gun. The first operational B-29s were delivered in the fall of 1943, and they first saw action in June of 1944 in an attack on Bangkok. No Superfortresses performed in Europe during the war, but they did a lot of damage in and around Japan. *Enola Gay* and *Bock's Car*, both B-29s, gave the model the unique, if suspect, distinction of being the only bomber ever to drop atomic bombs onto populated areas.

Specifications: *Type*: High altitude heavy bomber; *Power Plant*: Four 2,200 hp Wright R-3350-23 Duplex Cyclone 18-cylinder radials each with two exhaust-driven turbochargers; *Wingspan*: 141.3 ft; *Length*: 99.0 ft; *Height*: 27.8 ft; *Weight*: 135,000 lbs (loaded); *Maximum Speed*: 357 mph; *Ceiling*: 36,000 ft; *Range*: 3,250 miles; *Armament*: One 20mm cannon, one twin 0.50 cal. machine-gun, 22,000 lbs of bombs.



*A ground-breaking bomber and a tour de force in quick design and production of a military aircraft.*

## AIR COMBAT IN VIETNAM

Vietnam, following a century of French colonial domination and five years of hostile Japanese occupation, was formally divided into two parts (North and South) by the Geneva Conference of 1954. Nationalist leader and left-wing reformer Ho Chi Minh controlled all the territory above the 17th Parallel. Below the parallel, U.S. backed Ngo Dinh Diem exercised power. For the next five years, arguments of legitimate national elections ensued, while both the United States and the Soviet Union furnished industrial and military technologies to the South and North respectively. In 1959, North Vietnamese guerrillas began raiding South Vietnam in an effort to unify the country by force. Ngo Dinh Diem fell in 1963.

By 1964, North Vietnamese regulars controlled two-thirds of the South. To keep the South from being completely overrun by the North Vietnamese, U.S. President Lyndon Johnson authorized a series of air-strikes code named "Flaming Dart", which took place on February 8 and 11, 1965. This was the beginning of the air war in Vietnam. Initially the air strikes had little effect in demoralizing the North Vietnamese. Indeed, they appeared to provoke further escalation. The Joint Chiefs saw no other alternative but to push for more and harder-hitting air campaigns against North Vietnamese targets. This new offensive, called Operation Rolling Thunder, carried with it strict restrictions as to what areas and which targets the pilots could attack. On April 3, the restrictions relaxed somewhat by now, U.S. aircraft encountered MiGs for the first time, neither side scoring a victory. The following day, however, in a well orchestrated hit-and-run attack, MiGs shot down two F-105s and escaped unscathed. The battle for air superiority had begun, and the U.S. Naval Air Command concerned itself with the problem of neutralizing the fast and maneuverable MiG 17.

American designers, believing that air-to-air missiles eliminated the possibility of traditional dogfighting, built a number of multi-role jets which lacked the capabilities of a pure fighter. The F-4 Phantom, at the time probably America's deadliest plane with its medium-range Sparrow missiles, fell only a little short of the MiG-17 in close-in performance, but it carried no cannons! As if this were not enough of a disadvantage to U.S. flyers, the U.S. rules of engagement specified that a pilot had to confirm his aircraft targets visually before firing a missile. In the case of the Sparrow, visual contact with the target generally meant you were too close to the target. In spite of all this, two F-4s scored America's first kills, downing two MiG-17s on June of 1965, in the phase of operations known as Rolling Thunder II.

The introduction of the MiG-21 Fishbed in late 1965 significantly upgraded North Vietnam's air-defence network. As a strictly clear-weather interceptor, it was practically unapproachable in fair conditions, but cloudy skies hampered its effectiveness, during which times it usually remained on the ground. As the American command gradually relaxed its target restrictions, and as the U.S.S.R stepped up its delivery of MiGs, more air combat occurred, though encounters were still infrequent by historical standards. Neither side dominated the skies. In April America unleashed Rolling Thunder IV, for the first time allowing bombing runs over the whole of North Vietnam (except for a few designated spots in and around Hanoi and Haiphong).

America's commitment to a deeper penetration of North Vietnam saw a sharp increase in the number of dogfights. In June of 1966, F-4s brought down a number of MiG-17. Later in the month a lone F-4 escort engaged several MiG-21 and, using Sidewinders, made the first Fishbed kill. By the end of the month, the Navy and the Air Force had combined for 15 kills against 2 losses (both to the Navy). The air-war was in full swing and the U.S., partly out of superior numbers and partly out of superior airmanship, had established a clear advantage over the North Vietnamese pilots. But that did not mean air superiority, for the North Vietnamese brought to bear a formidable ground defense network in the form of surface-to-air-missiles and potent anti-aircraft artillery. By the end of 1966, a full 85% of the 455 U.S. aircraft lost since the beginning of the war fell to SAMs and artillery.

As 1967 approached, U.S. pilots had destroyed 23 MiG-21s, all in air-to-air combat. A few well-planned bombing runs over NVAF airfields could well have curtailed MiG activity, but for some reason the enemy's airfields were listed as off-limits. Accordingly, plans were laid to lure MiG-21 squadrons into deadly traps. Operation Bolo

encompassed a series of aerial ruses designed to trick the NVAF into believing that slower, bomb-heavy aircraft were on the way, aircraft that were in fact missile-equipped F-4s. Provisions were also made to cut off their escape to the sanctuary of Chinese airfields. A well-conceived and thoroughly planned ambush, the trap was set on January 2, 1967, and the elite MiG-21 pilots walked right into it. U.S. Pilots scored seven confirmed kills, nearly half of the 15 MiG-21s known to be operating at the time. It was the USAF's most decisive victory of the war.

Fair April weather brought plenty of sorties, and for the first time in the war North Vietnamese pilots mounted a serious challenge to their American counterparts. In some 50 engagements, U.S. pilots shot down nine MiGs but lost seven of their own. But in May, the F-4 was finally retrofitted with a nose cannon, and with this the U.S. temporarily regained its marked superiority in the air. Not surprisingly, MiGs all but disappeared from the air in June and July. But in August they returned in full force, having developed effective new tactics to deal with the F-4s, which by now were escorting bombers on strikes against airfields. Political maneuvering between Washington had halted and restarted the air-strikes throughout August, September and October, and no victories were scored by either side. But when talks broke down in the October, the U.S. resumed full-scale bombing of North Vietnam.

The peace talks had given the NVAF much needed time to train pilots and develop new tactics so as to better defend its ground targets, and it had paid off. In addition, the North Vietnamese ground defenses were increased. So when the renewed offensives began, U.S. airmen faced a much more dangerous foe. Whereas in August the U.S. enjoyed an sizeable advantage in kill-to-loss ratio, by February of 1968 the NVAF had practically evened the score, downing eighteen U.S. jets in that six-month span while losing only five. The MiGs were evening the score. Over the next two years, very little air combat took place, both sides losing equally when they did meet. Meanwhile, both sides regrouped and resupplied their ground troops.

Continuing to furnish the South Vietnamese infantry with all manner of military equipment, the U.S. began withdrawing its own ground troops. By 1972, the ground defense of South Vietnam was left in her own hands. Even though much U.S. air power remained, the planes were used only for reconnaissance missions. But when it became apparent that North Vietnamese forces were readying themselves for another massive onslaught, U.S. President Richard Nixon authorized a series of bombing runs dubbed Linebacker.

Most of the air combat fought during the Vietnam War took place in 1972, during Linebacker I, which began in April with the immediate objective of slowing the North Vietnamese invasion. But as soon as enough planes and equipment arrived, the U.S. brought the full brunt of its air power to bear on North Vietnamese supply lines, which included the mining of critical harbors with specially modified Navy A-6 Intruders. In the years of relative calm between 1968 and 1971, the U.S. has made a few significant advances in weaponry and ordnance, namely a very reliable, laser-guided bomb designed for use on the F-4. These and other precision-guided "smart" bombs contributed greatly to the success of Linebacker I. In addition, improvements in radar and electronic countermeasures had the combined effect of frustrating the North Vietnamese ground defense systems, thereby forcing more MiGs into the air. The result, of course, was an increase in dog-fighting. In the latter part of June, during the heaviest raids of the offensive, more than 300 sorties were flown per day, with U.S. pilots generally besting their opponents. Interdictions of supply lines were largely successful.

Following unsuccessful peace talks in the winter of 1972, Linebacker II was undertaken. It lasted eleven days, during which pilots flew 729 sorties all told, destroying many hundred military/industrial buildings, railroad yards, and petroleum storage facilities. Faced with the prospect of the total destruction of their military resources, the North Vietnamese returned to the negotiating table on January 1, 1973. A permanent cease-fire was signed on January 23. The war was officially over.

**MAY 10, 1972**

The world's first all-missile aces, USAF Lieutenants Randall H. "Duke" Cunningham and his radar man, J.G. "Willie" Driscoll, earned this singular distinction on May 10, 1972, when they shot down three MiGs in one afternoon. Taking off from the USS Constellation in support of a bombing mission over Haiphong, the two men soon found the skies thick with MiGs, with still more climbing to engage them. Cunningham blasted two out of the air in short order, the second kill probably saving the life of the airman who was being hotly pursued.

The bombs dropped and the brief melee now over, Cunningham and Driscoll were alone and still fully fueled. Over the radio they heard reports of MiG activity to the east. Turning in that direction, the pilots saw what looked like a MiG-17 heading straight for them. Knowing as he did that the MiG's Atoll missile could not lock on to a head-on target, Cunningham expected his enemy to run. But no! This Communist was no coward; the MiG let loose a stream of cannon fire.

A classic dogfight ensued. Cunningham pulled up to avoid the cannon shells, expecting to turn back at the top of his climb and see his opponent fleeing for Hanoi. But before he reached the top, Cunningham looked over his shoulder to find, to his amazement, that his quarry was climbing with him, side-by-side, not thirty feet away. The pilot was wearing a leather helmet, goggles and a long scarf, like some sort of World War I ace. It was none other than the famous Col. Tomb, much celebrated for his skill and daring. Using the F-4's superior acceleration, Cunningham out-climbed his stylish adversary and turned over the top, whereupon the Communist in his more agile MiG fired his cannons again, again without success. For a brief moment, Col. Tomb was staring straight into Cunningham's six o'clock, until the American broke down into a steep, rolling scissors. Having put a few hundred knots between himself and Tomb, Cunningham zoomed up again into a pure vertical climb, attempting to achieve an altitude advantage, roll over, and let the MiG have it. But, as before, Tomb stayed right with him, unloading a few rounds as the F-4 reached the top and levelled off, missing his target once again.

At about this time, Willie Driscoll spoke up, suggesting to his pilot that they might do well to break off this engagement and head for home. Cunningham would not hear of it. He still had gas, and he wanted to continue the deadly, vertical dance with the costumed, Communist celebrity.

Now on their third climb together, practically side-by-side, Tomb tried to stay with Cunningham, top-out with him, and get in behind the F-4, as the MiG enjoyed better handling. Sensing this, Cunningham cut his throttle and put on the brakes, hoping to fall in behind the MiG. But Tomb turned the tables, breaking off for a moment and then swooping in behind the temporarily powerless F-4. At this point, Cunningham was in deep trouble, his only recourse to light the afterburners and hope to God the engines wouldn't flame out. The trusty J79s hung in there. The two pilots flew together for a moment in a flat scissors—if a wingman for either pilot had shown up now, the lone combatant would have been dead meat. All Cunningham wanted to do at this point was disengage, try for a shot at the MiG's belly, and head home; but as he began to execute this final maneuver, Tomb turned and himself dove for home, probably low on fuel. This was all Cunningham needed. The MiG wound up right in his sights. Cunningham pushed a button and that was that. After all the jockeying, the kill was too easy. The flaming MiG dug a hole in the landscape for the valiant Col. Tomb. Cunningham and Driscoll went back to their ship, to the praise of their fellow fliers.

## AIRPLANE DESCRIPTIONS

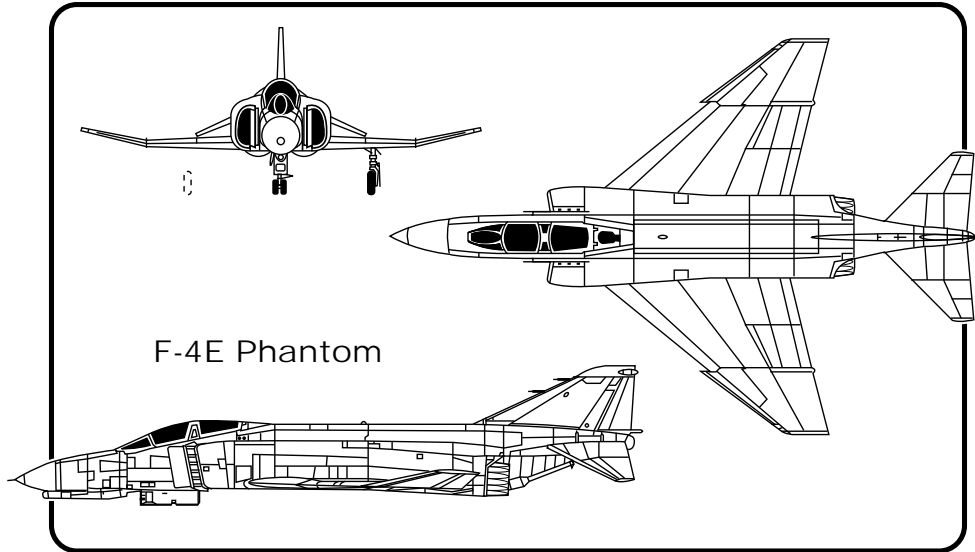

## MCDONNELL DOUGLAS F-4E PHANTOM II

Early in 1961 McDonnell Douglas came out with its first F-4 Phantom II, a plane, produced in serial for the next eight years, which would break no less than 15 records. The Navy's first fighter to carry nothing but missiles, it was also the first jet capable of identifying and destroying a target without help from the ground. Its designers were some of the most talented in the world, and they were able to strike a perfect balance between weight and power, between maneuverability and payload.

On August 5, 1964, over Vietnam, Phantoms off the carrier *USS Constellation*, saw the jet's first combat action. It was immediately apparent to the pilots that, given their orders to make visual contact before firing their four radar-guided Sparrow missiles and two heat-seeking Sidewinders, they were at a disadvantage against the cannon-bearing MiGs. Accordingly, designers installed a cannon in the F-4's nose, this model being the F-4E. These Phantom IIs are credited with more MiG kills than any other fighter.

Specifications: *Type:* Two-seat fighter; *Power plant:* Two 17,900 lb thrust General Electric J-79-GE-17A turbojets; *Wingspan:* 38.4 ft; *Length:* 62.8 ft; *Height:* 16.5 ft; *Weight:* 28,000 lbs; *Maximum speed:* 1,386 mph; *Climb:* 61,400 ft/min; *Ceiling:* 71,000 ft; *Range:* 786 mph; *Armament:* One 20mm M61A1 rotary cannon, four AIM-7 Sparrows, four AIM-9 Sidewinders.

AIM-7 Sparrow: *Guidance:* Semi-active radar homing; *Propulsion:* Solid propellant rocket; *Warhead:* 88 lb barthelet continuous rod; *Length:* 12 ft; *Weight:* 503 lbs; *Diameter:* 8 in; *Wingspan:* 3.3 ft; *Maximum Speed:* 3.5 Mach; *Range:* 30+ miles.

AIM-9 Sidewinder: *Guidance:* Infrared homing; *Propulsion:* Solid propellant rocket; *Warhead:* 25 lb fragmentation; *Length:* 9.4 ft; *Weight:* 190 lbs; *Diameter:* 5 in; *Wingspan:* 2.08 ft; *Maximum Speed:* 2.5 Mach; *Range:* 5 miles.



*A very versatile aircraft that accounted for the majority of the MiG-21 kills in Vietnam.*

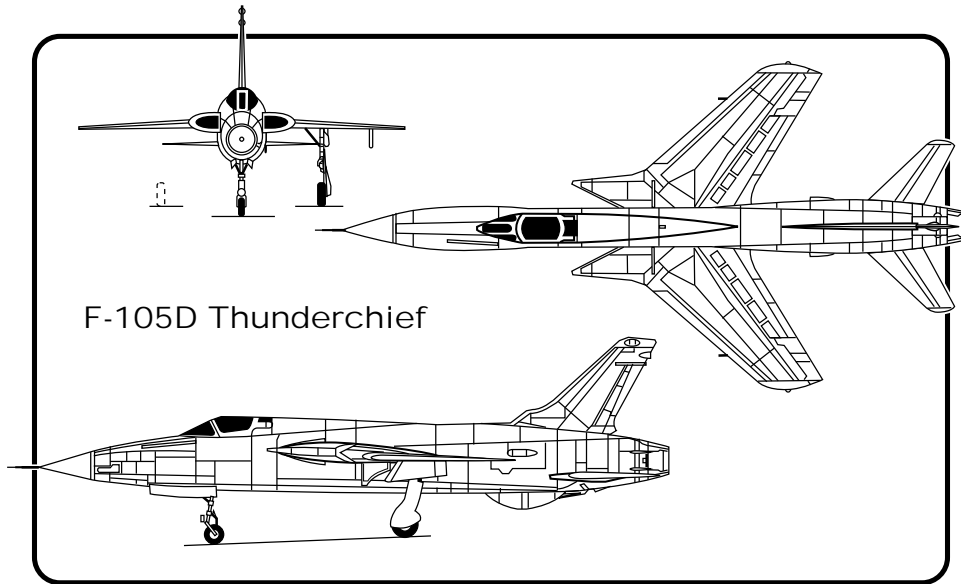

#### REPUBLIC F-105D THUNDERCHIEF

The F-105 was designed as a fighter-bomber capable of delivering nuclear weapons as well as a heavy payload of conventional bombs, and in October of 1955, when it made its maiden flight, it was both the largest and heaviest single-seat fighter ever built. The prototype reached Mach 1.2 easily, despite being powered by an engine smaller than the one projected for its design. Once the intended power plant was installed and a flaw in its fuselage corrected, the Thunderchief reached Mach 2.15, an awesome accomplishment considering its size.

In addition to the 14,000 lbs of bombs, missiles and rockets it could carry, the "Thud" sported one fixed 20mm cannon in its nose. During the course of the Vietnam war, in which it flew more than 20,000 bombing sorties beginning in March, 1965, 350 F-105s were shot down, mostly by anti-aircraft fire. The first F-105D came off the line in June, 1959 and would distinguish itself as the best all-weather aircraft in its class, meaning that it could be flown in virtually zero-visibility conditions and deliver its payload with the aid of a bombing computer. Being somewhat clumsy as a pure fighter, it was widely used in weather conditions unfavorable to enemy interceptors. Still, "Thud" pilots chalked up a modest 27 MiG kills in 1966 and 1967, and their success increased a year later when escorted by F-4s.

Specifications: *Type:* Single-seat fighter-bomber; *Power Plant:* One 17,200 lb thrust Pratt & Whitney J-75-19 turbojet; *Wingspan:* 34.9 ft; *Length:* 67.0 ft; *Height:* 19.8 ft; *Weight:* 27,500 lbs; *Maximum Speed:* 1,226 mph; *Climb:* 34,500 ft/min; *Ceiling:* 48,500 ft; *Range:* 800 miles. *Armament:* One 20mm cannon, two 3,000 lb bombs, and four Sidewinder missiles.



*A dependable airplane that could absorb a lot of damage and still fly. The F-105 flew more than 75% of Air Force's strike missions in Vietnam with just a 1% abort rate.*



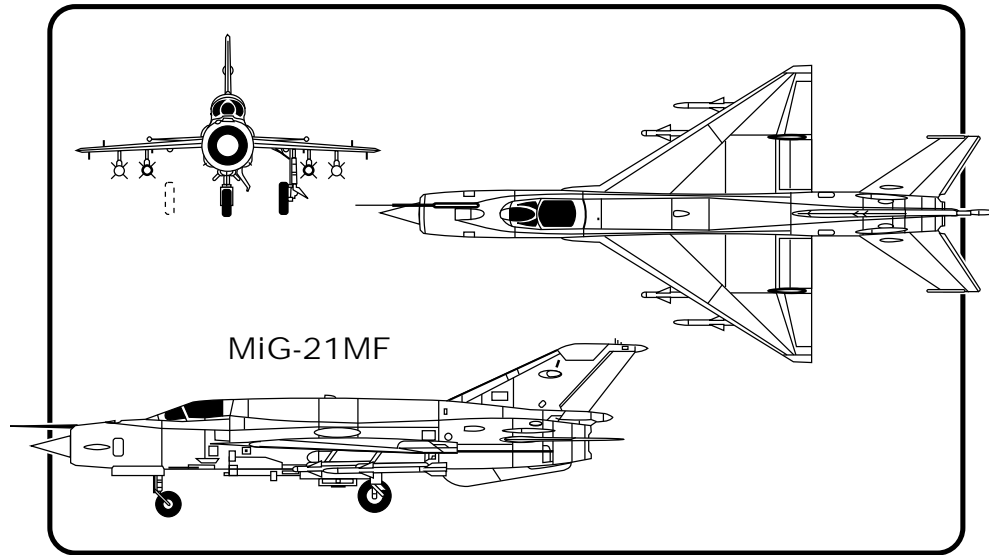

#### MIKOYAN-GUREVICH MiG-21MF FISHBED

The MiG's poor showing in Korea led directly to the development of the MiG-21, a short-range air-superiority fighter destined to become the world's most widely used combat aircraft. Designed in the 18 months following the Korean cease-fire, its developers chose a small airframe with a delta-shaped wing, emphasizing the highest possible performance in a short-term engagement. Accordingly, its fuel supply was completely internal, leaving room under its brief wings for missiles and avionics.

So many versions of the original design have been built that it is only possible to speak generally about the MiG-21. Most carried (or carry) at least one 23 mm cannon under the fuselage, and all support guided missiles of one variety or another, the versatility of its simple design being second among its virtues—the chief being its pure speed. The MiG-21 set many a speed record in its heyday. The 21NF entered the Soviet arsenal in 1970, equipped with a new single-shaft turbojet engine capable of mustering 11,240 lbs of thrust for a maximum speed of nearly 1,300 mph. Used extensively in the latter years of the Vietnam war, this version of the Fishbed made U.S. daylight missions a risky business. In 1973 production of this model began in India, and versions of the MiG-21 are currently in use throughout the world.

**Specifications:** *Type:* Single-seat fighter; *Power Plant:* One 11,240 lb thrust Tumansky single-shaft turbojet; *Wingspan:* 23.5 ft; *Length:* 48.0 ft; *Height:* 14.8 ft; *Weight:* 11,464 lbs; *Maximum Speed:* 1,285 mph; *Climb:* 36,090 ft/min; *Ceiling:* 59,050 ft; *Range:* 683 miles; *Armament:* Two 30mm NR-30 cannon, four AA-2 Atoll missiles.

*AA-2 Atoll:* *Guidance:* Infrared or semi-active radar homing; *Propulsion:* Solid Propellant Rocket; *Warhead:* unknown; *Length:* 9.1 ft; *Weight:* 155 lbs; *Diameter:* 4.75 in; *Wingspan:* 1.7 ft; *Maximum Speed:* 2+ Mach; *Range:* 4 +miles.



*A real success story for Russian arms sales. The MiG-21 was put on the drawing board after Korea, where the Soviets discovered they needed a light, single-seat interceptor with supersonic capabilities. It's been a popular fighter since.*

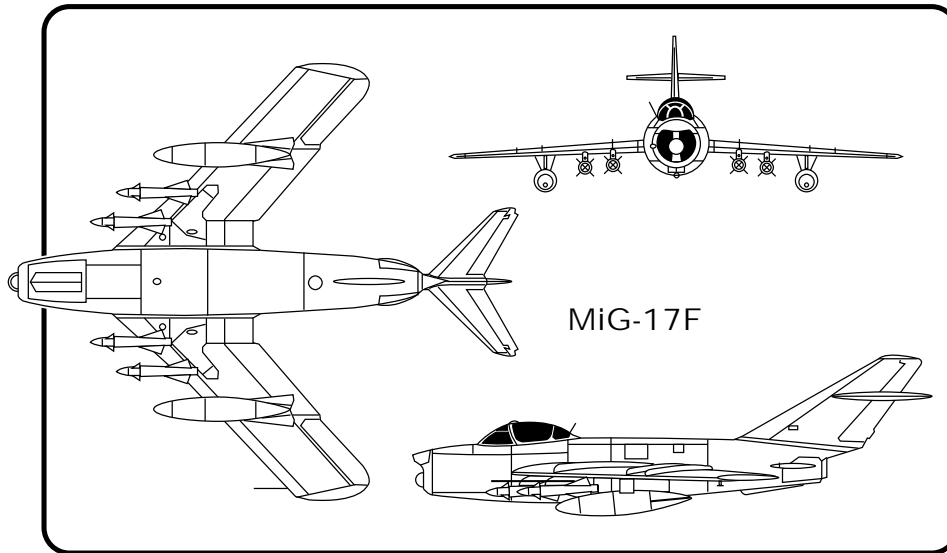

#### MIKOYAN-GUREVICH MIG-17F FRESCO

Already on the drawing board well before the Korean War began, the designers of the MiG-17 were trying to do more than simply iron out the MiG-15's flaws. In truth, it was a wholly different fighter, with a longer fuselage, a thinner wing, and a new tail. In addition, the MiG-17 was equipped with up-to-date radar and avionics and four wing hardpoint fuel tanks. Initially, it used the same power plant and armament as its predecessor, but those were later quickly dropped in favor of more powerful and destructive technology respectively. The 'F' version, of which more were produced than any other, was the first to have afterburners. As for its weaponry, it sported three 23mm cannons under its nose, eight 55mm air-to-air or air-to-ground rockets, and up to 1,100 lbs on bombs.

Not produced in sufficient numbers to influence the fighting in Korea, some of the top Communist aces in Vietnam piloted the Fresco. Like the MiG-15, the MiG-17 also was produced in Poland, Czechoslovakia, and China, eventually winding up in the air forces of some twenty-two countries besides the USSR. Praised by aircraft designers world-wide for the genius of its simplicity, the Fresco was to be the last jet in which Gurevich had a direct hand.

Specifications: *Type:* Single-seat fighter-interceptor; *Power Plant:* One 5,952 lb thrust Kilmov VK-1 single shaft centrifugal turbojet; *Wingspan:* 31.0 ft; *Length:* 36.3 ft; *Height:* 11.0 ft; *Weight:* 9,040 lbs; *Maximum speed:* 711 mph; *Climb:* 12,795 ft/min; *Ceiling:* 54,460 ft; *Range:* 870 miles; *Armament:* Three NS-23 cannons under nose, up to eight rockets.

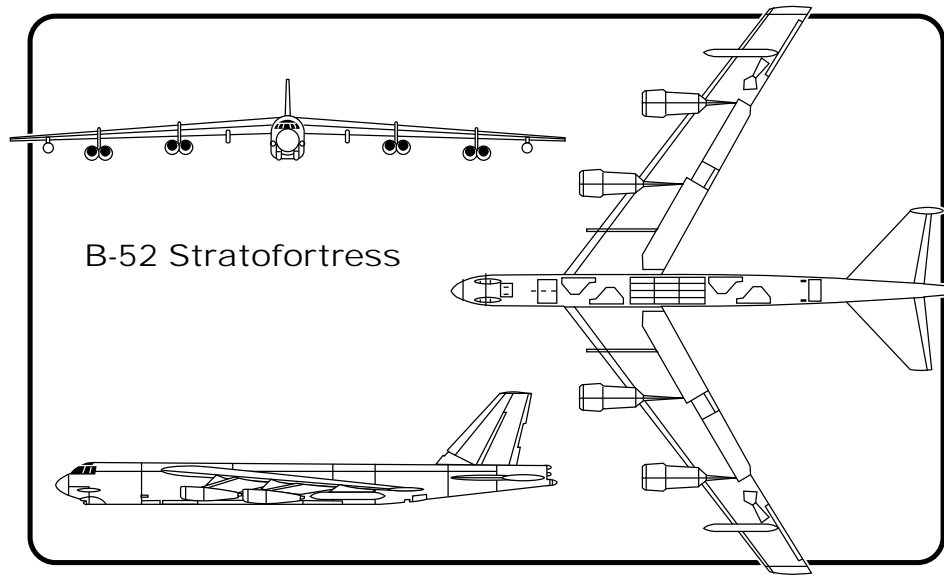

### BOEING B-52 STRATOFORTRESS

In 1945 the USAF asked Boeing to design a long-range heavy bomber, a bomber rangy enough to hit any target on the planet. Fuel-economy became the first issue. The bomber would have to be fast enough to make it escortable by fighters, but the first turbojet engines were far too thirsty to power the kind of aircraft the Air Force had in mind. A turboprop engine, being much more fuel-efficient, was the obvious choice. After numerous design changes, it became apparent that, turboprop or not, the bomber would have to be air-refueled to make it to certain trans-global targets. By the time it was finished in 1954, a full nine years from drawing board to assembly line, the first B-52 was driven by eight wing-mounted turbojets. For years it has been backbone of U.S. Strategic Air Command.

The B-52, used as recently as 1991 in the Persian Gulf War, had an enormous bomb bay and in addition could carry up to twenty short-range attack missiles. There was also a remote-controlled cannon turret in the rear of the bomber. Used extensively in Vietnam, the B-52 was and is continually modified to meet changing military requirements, and the USAF expects it to remain a viable strategic bomber into the next century.

Specifications: *Type:* Strategic Heavy Bomber; *Power Plant:* Eight 13,750 lb thrust Pratt and Whitney j57-P-43W turbojets; *Wingspan:* 185.0 ft; *Length:* 157.6 ft; *Height:* 40.7 ft; *Weight:* 480,000 lbs; *Maximum Speed:* 665 mph; *Ceiling:* 55,000 ft; *Range:* 9,000 miles; *Armament:* Two 20mm cannon in remotely controlled tail position, 20 SRAM missiles, bombs.



*For years, the B-52 was the backbone of the Strategic Air Command. It flew in Vietnam, but due to the fact that the bomber was susceptible to surface-to-air attacks, it was restricted to bombing missions in the south.*

---

## THE MAKING OF AN ACE

---

Electronic Arts: It's a fact that in every air war, a small number of pilots runs up the majority of kills. What characteristics make an ace?

Chuck Yeager: Experience. You start from a baseline of very good eyesight, stamina, and aggressiveness, but after that, it's strictly experience. The guy with the most experience is going to be the best.

EA: How do you get experience?

Yeager: You survive.

EA: When did you discover you had superior eyesight?

Yeager: When I was a kid. I was always gifted with good eyesight, from a kid on up. Even to this day I have 20/10 eyesight, which is twice as good as normal.

EA: I've read about pilots' focusing out to infinity.

Yeager: That's really an art you have to learn. Most people have difficulty focusing on infinity — they've got to have something to focus on. In World War II, we learned to pick a piece of the sky and focus out to infinity and back, and then move over and do it again. You don't let your eyes focus on a set place. Normally, if your eyes relax they focus at about 18 feet — you've got to be able to focus them out and in.

EA: Did radar change the importance of good vision?

Yeager: Yes. Radar caused the pilots to get lazy. They were using radar to look out 20 to 30 miles ahead. Before we had radar, you had to depend on your eyes to pick up things coming in. But now with the ability to jam radars, and also stealth technology coming into the picture, we've got to teach the guys to start looking again.

EA: You mentioned stamina...

Yeager: If you're dogfighting and pulling high g's, it's rough work, so you have to have stamina.

EA: You didn't have hydraulically operated controls.

Yeager: Yeah, it was harder work in the old days when you had to manually move the control surfaces at high speeds. But even today, although you've got systems that do the work for you, you're still exposed to high g loads, which is tough on you.

EA: Does the pilot's agility make a difference at all?

Yeager: To me, "agility" just means the ability to move around. You don't do much moving around in a cockpit!

EA: You're moving your hands...

Yeager: That's dexterity.

EA: OK. So how many controls did a World War II pilot have to monitor?

Yeager: In airplanes of World War II vintage, the systems were simpler — you just had a fuel system and that was it — but they were harder airplanes to fly. You had torque, trim, and the lack of boosted controls. Today's airplanes are more complex but they're much easier to fly.

EA: They do more of the thinking for themselves.

Yeager: That's right. It just makes you more effective, especially with computer-enhanced systems.

EA: Would you describe most pilots as cool-headed?

Yeager: "Cool-headed"? What you *don't* do is worry about the outcome of anything because you don't have control over it. You concentrate on what you're doing. If you want to call that "cool-headed," fine.

EA: It's a matter focusing, then?

Yeager: There you are. You focus on what you're doing.

EA: Were there guys up there who panicked?

Yeager: Obviously, if you're getting ready to get killed, I'm sure you get a little bit excited.

EA: What does training do for you?

Yeager: Here again, there's no substitute for actual combat. You can train and learn to fly your airplane, and that's experience. It all helps. We figured that if a guy survived his first five combat missions, then he had a good chance of surviving all the way through.

One thing we saw in World War II was that only 11% of the fighter pilots involved in combat with the Germans shot down about 90% of the airplanes destroyed. That's a small number. If you look at the commonality of these guys, they were all rural kids — they understood deflection shooting — they had good eyesight, and were aggressive and self-sufficient.

EA: You learned marksmanship while hunting as a kid?

Yeager: Very much so.

EA: You mentioned aggressiveness. How do you balance that with caution?

Yeager: That comes with experience. You know what to do and what not to do. But if you get an advantage, you've got to press it home.

EA: So one situation might demand aggressiveness, and another caution?

Yeager: Yeah. I mean, obviously you don't go jumping into the middle of 25 aggressive airplanes by yourself! You use your good judgement — call in some of your buddies.

EA: At one point, "situational awareness" became a buzzword. Does the term hold any meaning?

Yeager: Sure. You have the ability now with computer-enhancement and radar and stuff like that to increase your situational awareness. You know what's going on around you. See, the only way we knew what was going on around us in World War II was that we had a wingman. Obviously he was the guy who kept you aware of what was going on around you. If some guy was trying to work in on your tail it was his job to call a break.

Today, the ultimate situational awareness is AWACS. Those guys can tell you everything that's going on in the whole theater!

EA: How much does superior equipment help the fighter pilot?

Yeager: Iraq is a good example of what high-tech weapons will do for you. Superior weapons means the difference between winning and losing!

EA: In an air battle, does the *number* of aircraft make a difference?

Yeager: No, not necessarily so. Not today. It depends on the situational awareness the airplane provides, the kind of missiles you're using, what kind of ECM equipment the enemy has. The outcome depends on all of these things, because the situation changes real quick in an air battle. As far as superior numbers go, if you're equal in the technology of your weapons, superior numbers will win because there'll be more pilots who survive.

EA: Have missiles changed the nature of air combat?

Yeager: Today's missiles are making a gun excess baggage. If you look at Iraq, there wasn't one airplane shot down with a gun except a helicopter shot down by an A-10. But all of the fighters types — strictly missiles.

EA: Missiles have improved a lot since Vietnam.

Yeager: Oh, definitely. In Vietnam, the kill ratio and reliability was sad because they were new. Today — hey, we're running at 99-100% success rate.

EA: So they were a little hasty in the early days of Vietnam when they took out those guns?

Yeager: It's a learning curve. Just like in World War II with our P-51s, we had these ring and bead gun sights. You depended on your instinct to shoot a guy down. So they developed a lead computing gun sight — the K-14. Made it easier. We had to learn how to use it. It's the same with the missiles.

EA: Air combat is often seen as a kind of chivalric contest or even a sport. What's your opinion of that notion?

Yeager: It's a sport?!

EA: You hear that as an analogy.

Yeager: Well, that's just the press! No, air combat in a war is why they pay you to fly. It's that simple. That's what you're trained for. You don't train just to put on air shows. It's a job — you have to maintain a combat readiness and you've got to be ready to fight. It's basically that simple.

But it is this — air combat is the ultimate flying experience.



## GLOSSARY

- Ace** A pilot who has five confirmed kills.
- Afterburner** A device for gaining extra thrust at the expense of greatly increased fuel consumption by igniting fuel directly in the exhaust engines.
- Ailerons** Hinged surfaces at the trailing edge of each wing, typically near the wingtips. Ailerons control the plane's roll.
- Altimeter** Instrument used to measure the height (in feet) of the airplane above sea level.
- Angle of Attack** The angle at which the wing meets the oncoming air. The greater the angle of attack, the more lift occurs as air striking the bottom of the wing is deflected downward. If the angle of attack is too great, the airplane stalls.
- Angle of Deflection** See Deflection Angle.
- Angle-Off** See Deflection Angle.
- Attitude** The direction the nose of the airplane is facing.
- Auger In** Crash.
- Back Pressure** Pulling back on the flight stick.
- Bandit** An enemy plane.
- Blackout** The effect of high positive g's on the human body, causing blood to rush away from the head and the pilot to momentarily blackout. See also Redout.
- Bogey** An unidentified airplane.
- Bounce** Make a surprise attack on an opponent.
- Bug Out** Disengage combat.
- Buy the Farm** Die.
- Center of Gravity** The point at which the longitudinal, lateral, and vertical axes of the airplane cross.
- Control Surface** Parts of the airplane that can be moved to affect the airplane's flight: ailerons, elevators, rudder, and flaps.
- Deflection Angle** Angle of a target off of the attacker's longitudinal axis. A high angle of deflection makes it difficult for an attacker to aim.
- Dogfight** The maneuver phase of air combat in which opposing pilots attempt to shoot down or evade the enemy.
- Drag** Resistance created by air striking the surface of the aircraft as it moves through the atmosphere. Drag increases with velocity and angle of attack.
- Elevators** Hinged surface at the trailing edge of the horizontal stabilizer. Elevators control the aircraft's pitch.
- Flame** To shoot destroy an enemy aircraft.
- Flaps** Hinged surfaces on the trailing edge of the wings, typically near the fuselage. Flaps can be lowered to increase lift and drag.
- Flight Stick** The control device in the cockpit used to direct roll and pitch.
- G-Force** Gravitational force. One g equals the amount of pressure exerted on someone standing on earth. Also, a measure of how hard an airplane's turning.
- Glareshield** An airplane's windshield.
- Go-Stick** Throttle.
- Heading** The direction the aircraft is pointed, as indicated by the heading indicator.
- HUD** Heads Up Display. In Air Combat, also called Flight Info.
- Jump** Make a surprise attack on an opponent.

**Kill** A downed aircraft credited to a pilot.

**Lateral Axis** Axis of the aircraft that extends from wingtip to wingtip.

**Lead** To shoot downrange of a target's position.

**Lift** The upward force generated by air flowing over the wings.

**Longitudinal Axis** Axis of the aircraft that extends through the fuselage from nose to tail.

**Mach** The Mach number is the ratio of true airspeed to the speed of sound. One Mach is 761 mph at sea level, decreasing to 660 mph at 36,000 ft.

**O Club** Officer's Club.

**Pitch** Rotation about the aircraft's lateral axis, pointing the aircraft's nose up or down.

**Redout** The effect of high negative g's on the human body, causing blood to rush to the head and the pilot to momentarily see red. See also *Blackout*.

**Roll** Rotation about the aircraft's longitudinal axis.

**Rudder** The hinged surface on the vertical stabilizer that controls the airplane's yaw.

**Service Ceiling** The altitude at which the engine no longer has enough power to maintain a climb rate of 100 feet per minute.

**Situational Awareness** — A fighter pilot's ability to track the complexities of a fast-moving, dynamic combat situation.

**Sortie** A mission flown by an airplane.

**Stall** A situation in which air no longer flows smoothly across the upper surface of the wing, greatly reducing lift. A stall occurs when your speed is low.

**Stick** The control device in the cockpit used to direct roll and pitch. Also called the flight stick.

**Structural Failure** The speed at a given altitude at which the airframe of the aircraft can no longer withstand air resistance.

**Throttle** The control that sets the engine's power output.

**Thrust Limit** The speed at a given altitude at which an airplane is no longer capable of generating lift.

**Thrust/Weight Ratio** The maximum amount of thrust (engine power) available to push the airplane's weight through the air. This is an important factor in determining a fighter's acceleration. The higher the thrust/weight ratio, the faster the airplane will accelerate.

**VSI** Vertical speed indicator. An instrument that measures the rate of climb or descent.

**Vertical Axis** Axis of the aircraft that extends vertically from top to belly.

**Vertical Stabilizer** The vertical section of the tail. Also called the fin.

**Victory** A downed aircraft credited to a pilot.

**Wing Loading** Wing loading is the amount of weight per square inch on the wing surface.

**Yaw** Rotation about the aircraft's vertical axis.

## APPENDIX: HUD MESSAGES

## AIRCRAFT DAMAGE

## "ENGINE DAMAGED"

Your engine is mostly all right, but its maximum power is decreased. If you try to set the engine at 100% power, it'll "top out" at the new max.

## "ENGINE SERIOUSLY DAMAGED"

Something major has gone wrong with your engine and starts to make a "rough," irregular sound. It is probably starting to overheat, in which case you'll soon see "ENGINE OVERHEATING".

## "TURBINE FAILURE"

## "COMPRESSOR FAILURE" and

## "ENGINE FAILURE"

Critical parts of your jet engine have failed, causing an immediate total loss of power. The first two messages appear only if you're in a jet, the third only if you're in a prop.

## "FUEL TANK ON FIRE" and

## "FUEL TANK FIRE EXTINGUISHED"

Your plane will explode in 10 - 15 seconds. There's a small chance the fire will go out before then. That chance increases if you speed up. If it goes out, you'll see the second message.

## "RADAR DAMAGED"

Your radar has been rendered inoperable, which means:

- your cockpit radar display shuts off
- you can't get a lock with radar-guided missiles
- your gun sight no longer uses accurate range, and therefore is less accurate in computing lead.

## "ELEVATORS DAMAGED"

You can only pull 50% of your usual g's.

## "AILERONS DAMAGED"

You can only roll half as fast as before.

## "FLAPS JAMMED"

## "GEAR JAMMED" and

## "BRAKES JAMMED"

You can no longer operate the item listed.

**"WING DAMAGED"**

Your wing now generates less lift and more drag.

**"GUNS DAMAGED" and****"MISSILES DAMAGED"**

This appears when either an entire weapon has been destroyed or the ammunition for that weapon is no longer available (e.g., broken ammo belt, etc).

**"OIL LINES DAMAGED"**

When oil runs out, your engine starts to overheat.

**"HYDRAULIC LINES DAMAGED"**

When hydraulic fluid runs out, you can't toggle brakes, flaps, or gears. In F-86, F-4, MiG-21, your hydraulic-boostered controls lose their responsiveness while the fluid is running out.

**"FUEL TANK DAMAGED"**

Your fuel starts to leak.

**"CONTROL LINES DAMAGED"**

The controls start to move erratically and you have to correct for it.

**"STRUCTURAL DAMAGE"**

Due to damage to your plane's overall structural integrity, any time you pull  $\geq 5g$  or  $\leq -4g$ , your plane may fall part in midair (about 1% chance per second when you're within the limits).

**"CHAFF DISPENSERS DAMAGED" and****"FLARE DISPENSERS DAMAGED"**

You can't use that device any more.

**"YOU'VE BEEN HIT"**

You'll die in 10 - 15 minutes if you don't return to your base.

**"YOU'VE BEEN SERIOUSLY INJURED!"**

You'll die in 1 - 2 minutes if you don't return to your base.

**"YOU ARE ABOUT TO DIE FROM YOUR WOUNDS!"**

Pray that St. Peter has your name on his list.

**"OUT OF FUEL"**

Your engine shuts down due to lack of fuel.

**"OUT OF OIL"**

You've run out of oil. Your engine will now start to overheat. You'll soon see the following message...  
"TO PREVENT THE ENGINE FROM OVERHEATING, YOU CAN SET THROTTLE TO 0%, THEREBY SHUTTING THE ENGINE OFF. THIS WILL CAUSE IT TO GRADUALLY COOL, BUT IT'LL HEAT UP AGAIN IF YOU TURN IT ON AGAIN."

**"ENGINE OVERHEATING"**

Your engine has reached 50% of its max temp. When it reaches 100%, the engine will catch on fire, and you'll see...

**"ENGINE ON FIRE"**

After your engine temperature reaches maximum, your engine catches fire and this message appears. In about 10 - 20 seconds, your plane will explode.

**"YOUR PLANE IS ABOUT TO EXPLODE!"**

If you've taken 100% of your max damage (see the "d" command for your current status), any additional hit you take can cause your plane to fall apart/blow up. When this happens, you'll see this message. You'll have 5 - 10 seconds to bail out before your plane blows up.

**FLIGHT CONDITIONS****"MACH 1.0 EXCEEDED"**

You have broken the sound barrier.

**"APPROACHING STALL"**

In a second or two you will begin to stall. Point nose down, set max thrust.

**"STALL"**

You're stalling. Point nose down, set max thrust

**"THRUST LIMIT"**

You're at your max speed for this altitude. Your engine can't generate enough thrust to make you go any faster.

**"EXCEEDING MAXIMUM SPEED"**

You've exceeded your plane's max speed at this altitude. If you continue to over-stress the plane by staying outside of the envelope (it takes at least 15 seconds), you'll see the message below. You should slow down by chopping the throttle, pulling up, putting out your flaps and speed brakes, etc.

"WING STRUCTURE FAILING"

When you see this, you'd better slow down or else your wings will rip off. Act fast.

"WINGS RIPPED OFF"

You poor child, you stayed over your maximum speed for so long that your wings couldn't stand the stress and ripped off. You're on your way to becoming part of the landscape beneath you. Sayonara!

## SUGGESTED READING

## WORLD WAR II

The P-51 Mustang has no shortage of books written about it, but a good one for measuring its dogfighting capability is *Combat Profile: Mustang*. This book covers several individual missions flown by a P-51 pilot, and compares its various aerodynamic qualities with several other popular World War II fighters.

It's always a good idea to see both sides of a story, so you might want to read *Horrido!* for a good history of the Luftwaffe's best.

For two contrasting views of the Me-163 Komet, check out *Rocket Fighter* and *Top Secret Bird*. The former, written by a test pilot in the 163 program, is naturally oriented toward the day-to-day operations of the group, and the personalities of the various pilots. Strangely, the author gives a lot of attention to the 163's habit of exploding at unexpected times. *Top Secret Bird*, written by the commander of the program, deals to a greater extent with the back-room maneuvering that was required to design and manufacture the plane, and the politics necessary to get a squadron organized.

## KOREAN WAR

*The Great Book of Modern Warplanes* contains information about various MiGs, including the 15 and the 21. There's only a little information about the 15, but it's more than you'll find in most other places. This book is impressive not only for its great detail, but also for its sheer heft. It's one of the most lavish coffee-table books around.

The F-86 is one of the few "classic" fighters, but there isn't much written about it either. *Famous Aircraft Series: The F-86 Sabre* is the only 86-specific book we found, and its author was in the Canadian air force and never saw combat.

## VIETNAM

For a peek into the minds of Soviet airplane designers, as well as more than you ever wanted to know about a classic Soviet fighter, see *Mikoyan MiG-21*.

For information about the F-4 (and a number of other planes), see *The Great Book of Modern Warplanes*. This book includes details of the F-4's most famous air battles, though mainly it focuses on aircraft technology. For a look at what it was like to actually be an F-4 pilot, see *Phantom Over Vietnam*. This book is good for getting a feel for the various technical procedures a fighter pilot has to know, material commonly left out of more celebratory books about "dogfighting." *USN Phantoms in Combat* and *USAF Phantoms in Combat* contain the pilots' personal accounts of their most exciting combat missions in Vietnam, plus lots of photographs.

*Linebacker* is a blow-by-blow record of the historical Linebacker I and II campaigns. Detailed information about sortie setups, the roles of various aircraft, their effectiveness, etc. . .

## MISCELLANEOUS

If you buy only one book about dogfighting, I recommend *Modern Air Combat*. This eight-year-old book is still the best introduction to air combat available. It contains enough pictures so as not to intimidate the casual reader, and enough detail that most enthusiasts can find something they didn't know. Remarkably, eight years later, most of the planes it presents are still front-line fighters and likely to remain so for ten more years!

For a detailed look at what makes a successful fighter pilot, see *The Ace Factor*. Using the major air wars as examples, Mike Spick finds that "situational awareness" is the key to success (and survival). This book doesn't cover actual air combat maneuvers in great detail, though. If that's what you want, you need *Fighter Combat*. It's not for the beginner, but it looks like the "last word" on the subject. One-on-one combat, one-on-two, one-on-many, similar aircraft, dissimilar aircraft, it's all in this hefty volume.

*Yeager: An Autobiography*. Need we say more?

*Aircraft Design* is a good beginner's guide to the making of a modern jet fighter. This book emphasizes planes that the author worked on, such as the A-4 Skyhawk, which happens to be a bomber. Still, most of the text is quite applicable.



## SELECTED BIBLIOGRAPHY

- Karl J. Eschmann, *Linebacker*. Ivy Books, New York, 1989.
- Bill Gunston, *Mikoyan MiG-21*. Osprey Publishing Ltd, London, 1986.
- John Trotti, *Phantom Over Vietnam*. Berkley Books, New York, 1984.
- Wolfgang Späte, *Top Secret Bird*. Pictorial Histories Publishing Company, Missoula, 1989.
- Mano Ziegler, *Rocket Fighter*. Bantam Books, New York, 1984.
- Roger A. Freeman, *Combat Profile: Mustang*. Ian Allan Ltd, Shepperton, 1989.
- Robert L. Shaw, *Fighter Combat*. Naval Institute Press, Annapolis, 1985.
- Mike Spick, *The Ace Factor*. Avon Books, New York, 1989.
- Bill Gunston and Mike Spick, *Modern Air Combat*. Crescent Books, New York, 1983.
- Raymond F. Toliver and Trevor J. Constable, *Horrido!*. Bantam Books, New York, 1968.
- Lou Drendel, *USAF Phantoms In Combat*. Squadron/Signal Publications, Carrollton, 1987.
- Lou Drendel, *USN Phantoms In Combat*. Squadron/Signal Publications, Carrollton, 1988.
- General Chuck Yeager and Leo Janos, *Yeager: An Autobiography*. Bantam Books, New York, 1985.
- Heinemann, Rausa, and Van Every, *Aircraft Design*. The Nautical & Aviation Publishing Company of America, Inc, 1989.
- Sweetman, Gething Richardson, Spick, Gunston, *The Great Book of Modern Warplanes*. Salamander Books LTD., New York, 1987.
- R.J. Childerhose, *Famous Aircraft Series: The F-86 Sabre*. Aero, a division of Tab Books Inc., Blue Ridge Summit, 1965.
- Mike Spick, *Jet Fighter Performance: Korea to Vietnam*. Ian Allan Ltd., Shepperton, Eng., 1986.
- John Trotti, *Phantom over Vietnam*. Berkley Books, New York, 1984.
- John Dienst and Dan Hagadorn, *North American P-51 Mustang in Latin Air Force Service* in Latin American Air Force Service. Aerofax Inc., Arlington, 1985.
- Tim McGovern, *McDonnell F-4E Phantom II*. Aerofax, Inc., Arlington, 1987.
- René Francillon, *McDonnell F-4D*. Aerofax, Inc., Arlington, 1985.
- Hans-Heiri Stapfer and Don Greer, *Fighting Colors: MiG-21 Fighbed in Color*. Squadron/Signal Publications, Carrollington, 1989.
- Larry Davis and Don Greer, *Fighting Colors: P-51 Mustang in Color*. Squadron/Signal Publications, Carrollington, 1982.
- Flight Handbook: Pilot Training Manual for the F-51D Mustang*. Flying Books, Publishers and Wholesalers, Eagen, 1954.
- J.S. Przemieniecki, *The Fundamentals of Aircraft Combat Survivability Analysis and Design*. American Institute of Aeronautics and Astronautics, Inc., New York, 1985.
- Roger A. Freeman, *Combat Profile: Mustang: The P-51 Merlin Mustang in World War 2*. Ian Allan Ltd., Shepperton, Eng., 1989.
- Michael O'Leary, *Jet Warriors*. Motorbooks International Publishers & Wholesalers, Osceola, 1990.
- Robert Jackson, *World Military Aircraft Since 1945*, Charles Scribner's Sons, New York, 1979.

## ABOUT THE MAN

Charles "Chuck" Yeager was born February 13, 1923 in Myra, West Virginia. He graduated from Hamlin High School and at age 18 he enlisted in the Army Air Corps, where he became an airplane mechanic. Enrolling in the "Flying Sargent" program, he distinguished himself as a natural pilot and earned his wings in 1943. From there he joined the 357th Fighter Group, the first all P-51 Mustang Group in the 8th Air Force. Over Nazi Europe he sent down 13 enemy aircraft, among them an Me-262, one of Germany's first jet-driven airplanes. Yeager was shot down over occupied France in March of 1944 and eluded the enemy with the help of the French Marquis, and he was soon back in the saddle.

After WW II, Yeager remained in the Air Force, serving as an instructor, test pilot, pilot, wing commander, and squadron commander in the United States, throughout Europe, and in the Philippines. On October 14, 1947 he became the first man to travel faster than the speed of sound, flying "Glamorous Glennis", a Bell X-1 aircraft. Six years later, he became the first man to exceed Mach 2, flying a Bell X-1A. Chuck Yeager was the top United States Air Force test pilot for a period of nearly ten years, and his subsequent career merited him an impressive list of credentials. He graduated from the Air War College, was appointed Commandant of the Aerospace Research Pilot School, became a brigadier general in 1969, and later the Vice Commander of the 17th Air Force.

Also, he has served as the Defense Representative to Pakistan and the Director of the Air Force Inspection and Safety Center. In 1975 Gen. Yeager retired, but in 1980 he began consulting for the Northrop Corporation.

### ARTIST BIO AND CREDITS

At age fifteen, Brent Iverson went to a friend's house to play games on an ancient Apple II. That was his first experience with a computer, and liked it a lot better than anything he was studying in school. Brent still thinks computers were made for playing games.

When he went to the University of Michigan,

Brent thought about majoring in Art but decided he liked money a little more than art. Brent majored in Computer Science instead.

Before coming to Electronic Arts in 1986, Brent worked for a company you've never heard of, doing things he's really ashamed of. Besides programming flight simulators, Brent programmed the IBM and Apple IIGS versions of DeluxePaint II (guess those two art classes didn't go to waste after all).

After meeting with Chuck Yeager recently, Brent said, "The more I learn about dogfighting, the more amazed I am that it really happens up there."

Game Designer: Brent Iverson  
 Programmer: Brent Iverson  
 Additional Programming by: Ken Hurley  
 Producer: Paul Grace  
 Graphics: Cynthia Hamilton  
 Music: George Sanger  
 Sound Effects: Mike Sanders, Dave Warhol  
 Technical Direction: Scott Cronce  
 Product Management: Lesley Mansford

Art Direction: Nancy Fong, Nancy Waisanen  
 Package Design: Zimmerman Crowe Design  
 Package Illustration: Dru Blair  
 Documentation Layout: Robert Gin  
 Lead Tester: Jeff Haas  
 Quality Assurance: Kurtis Hsu  
 Documentation: David "Bug Out" Luoto  
 Additional Writing: T. S. Flanagan  
 Manual Color Illustrations: Mike Farrar  
 Additional Illustrations: Adrian Bourne

## INDEX

- A**
- Aces: 118, 146, 153
  - Ace's challenge: 23
  - Afterburners: 35, 37, 44, 153, 157, 163
  - Ailerons: 73, 147, 163, 165
  - Air pressure: 73, 75, 78
  - Airplane descriptions: 128-144, 147-150, 154-158
  - Airplane movement: 72-77
  - Altimeter: 37, 163
  - Altitude: 10, 17, 23, 34, 72-80, 121, 164
  - Ammo: 15, 35, 166
  - Angle of attack: 75, 79-80, 84, 163
  - Answers to Copy Protection: 129-158
  - Artificial horizon: 36
  - Atoll missiles (see Infrared-guided missiles)
  - Attacking : 118
    - angle of attack (see Angle of attack)
    - attacking bombers: 113, 122
    - attacking the Me-110: 123
    - attacking two planes: 119
    - attacking with missiles: 118
    - barrel roll attack: 85, 104
    - dive attacks: 95, 105, 121
    - flank attacks: 122
    - frontal attacks: 122
    - ground attacks (see Ground attacks)
    - gun attacks: 118
    - head-on attacks: 123
    - rear attacks: 122
    - slash attacks: (see Slash attacks)
  - Attitude: 34, 163
  - Auger in: 163
  - Auto-save film: 56, 68
- 
- B**
- B-17E Flying Fortress: 132-133
  - B-29C Superfortress: 150
  - B-52 Stratofortress: 158
  - Back pressure: 163
  - Bandit: 163
  - Barrel roll: 97
  - Blackouts: 54, 163
  - Bogey: 163

Bounce: 25, 163  
Box view: 63, 67  
Brakes: 35, 37, 44, 73, 79, 84-85, 165-166  
Break: 83, 85  
Bug out: 163, 171

---

**C** Calibrating your joystick: 43  
Campaign mode: 25  
Center of gravity: 163  
Chaff: 166  
Chance to hit: 14, 35, 49  
Climbing: 84  
Clock, the: 51  
Closing: 117  
Cockpit: 8, 38, 42, 44, 76  
Communications: 34, 50, 52  
Controls  
    flight: 8  
    flight recording: 64, 68  
Countermeasures: 36, 50  
Custom scenarios: 25-28

---

**D** Damage: 35, 37, 53  
Debriefing: 24, 56  
Deflection angle: 85, 109, 163  
Detection: 37, 49  
Difficulty levels: 20, 21-22  
Dive: 14, 28, 42, 44  
    spiral dive: 105  
Dogfight: 17, 28, 45, 163  
Drag (see Four forces)

---

**E** Easy aiming: 23, 25, 58  
Easy landing: 59  
Ejecting from cockpit: 53-54  
Emergency procedures (see power dive)  
Ending a mission: 23  
Ending custom scenario (see Custom scenario)  
Ending historic mission (see Historic mission)  
Energy state, the: 80  
Envelope window: 60, 79  
Experience level: 11, 28

- 
- F**
- F-86E Sabre: 147
  - F-105 Thunderchief: 155
  - F-4E Phantom II: 154
  - Firing missiles: 48
  - Flaps: 14, 35-36, 44, 73, 163
  - Flares: 36, 50
  - Flight envelope: 72, 77-79
  - Flight info: 34, 58
  - Flight menus: 13-14, 42, 55-59
  - Flight path: 108
  - Flight performance recovery: 79
  - Flight recorder: 56, 64-69
  - Flight stick controls: 42-44
  - Four forces: 74-75
  - Fuel Gauge (see Gauges)
  - FW 190A-8: 134-135
- 
- G**
- G-force: 35, 76, 163
  - Gauges
    - DIR: 52
    - fuel: 37
    - hydraulic fuel: 37
    - NAV: 52
    - oil pressure: 37
    - temperature: 37
    - thrust: 37
  - Graphics menu: 57
  - Ground attacks: 123
  - Gun sights: 110
- 
- H**
- Heading: 34, 37, 52, 67, 163
  - Heads up display: 34, 58, 163
  - Heat-seeking missiles (see infrared-guided missiles)
  - Help features: 23, 25
  - Help menu: 58-59
  - Hints: 8, 16, 60
  - Historic mission: 20-24
  - Holdover angle: 109
  - Hydraulic fuel gauge (see Gauges)
- 
- I**
- Identification key for Box view: 67
  - Identify foe: 50
  - Identify friend: 50

Immelmann turn: 95

Indicators

brake: 35

chaff/flare: 36

flaps: 35-36

heading: 37

landing gear: 34, 36

speed: 36

vertical speed: 37

view mode: 65

waypoint: 36, 52

Infrared-guided missiles: 48, 50

Instrument panel: 12, 36-37, 44

Instrument check: 8, 34-35

Invincibility: 13

---

**J**

Jinking: 92

Joystick users: 47

Jumping: 163

---

**K**

Keyboard users

allowances in Campaign mode: 23

controlling flight stick: 47

rotating camera: 66

selecting options: 20

targeting and firing: 14, 48

Korean War: 145-146

---

**L**

L-5 Sentinel: 144

Landing: 86, 163

Landing gear: 34, 36, 73

Landing readiness: 35

Last mission: 31

Leading: 110

Level flight: 75-76, 78

Lift (see Four forces)

Linebacker I: 151

Linebacker II: 152-153

Loop: 93

---

**M**

Map identification key

for EGA, VGA, MCGA: 59

for CGA: 60

Me-109E Emil: 136-137  
 Me-110B Zerstoror: 138-139  
 Me-163 Komet: 140-141  
 Me-262 Sturmvogel: 142-143  
 MiG Alley: 145-146  
 MiG-15 Fagot: 148  
 MiG-17F Fresco: 157  
 MiG-21MF Fishbed: 156  
 Missiles  
   infrared-guided: 48, 50  
   radar guided: 49, 50  
 Mission statistics: 16, 24, 28  
 Mission debriefing: 24, 57  
 Mouse users  
   allowances in Campaign mode: 23  
   controlling the flight stick: 42-43  
   rotating camera: 65  
   selecting options: 20  
   selecting weapons: 47  
   targeting and firing: 13, 48  
   with hi-res mouse: 57

---

**N** Navigating: 52

---

**O** Oil pressure gauge (see Gauges)  
 Oxygen: 73, 78

---

**P** P-47 Thunderbolt: 128-129  
 P-52 Mustang: 130-131  
 Pipper: 34  
 Power dive: 84  
 Pursuit: 93

---

**Q** Quickstart: 7-17  
 Quitting: 8

---

**R** Radar: 50-51  
 Radar monitor: 36  
 Radar warning receiver: 37, 49-50, 56  
 Radar-guided missiles: 48  
 Radio: 35, 53  
 Redouts: 54, 59, 163  
 Review film: 31, 56, 68



Roll: 163  
Rollaway: 102  
Rotate view: 12, 47  
Rotating the camera: 65, 67

---

**S** Scan: 12-13, 47  
Scissors: 93  
Selecting weapon: 47  
Sidewinder missiles (see infrared-guided missiles)  
Situational awareness: 51, 159-162, 163  
Slash attacks: 117-118  
Sounds: 56-57  
Sparrow missiles (see radar-guided missiles)  
Split S: 94  
Stalling: 53  
Startup parameters (use command summary card)  
Stats screen (see Mission statistics)  
System menu: 56-60

---

**T** Tactical overview: 17  
Tactical positions: 26  
Tactics: 8, 114-123  
Take off: 86  
Target marker: 34  
Target range: 108  
Target windows: 13, 60  
Temperature gauge (see Gauges)  
Test flight: 29  
Throttle: 35, 44, 79, 163  
Thrust (see Four forces)  
Thrust gauge (see Gauges)  
Time compression: 35, 54, 57  
Time counter: 64  
Tracking: 50  
True air speed: 35  
Turning: 77

---

**U** Unlimited ammo: 58

---

**V** Vertical speed: 35, 37  
Vietnam War: 151-153

View keys: 12, 16, 45  
Vulnerability cones: 118

---

**W** Warnings: 35, 53  
Waterline marker: 34  
Weapons: 14, 22, 47  
Weight (see Four forces)  
Wheel brakes: 35, 37  
World War II: 126-127

---

**Y** Yak-9: 149  
Yeager window: 24  
Yeager, Chuck: 60  
Yo-yo  
    high: 97  
    low: 96

---

**Z** Zoom level: 35, 65, 67

---

## PROBLEMS WITH THE GAME? — TECHNICAL SUPPORT

---

If you are having a problem installing or playing the game, we want to help.

First, please make sure you have read the installation and/or “getting started” section of your manual or command summary card thoroughly. If you have followed the directions in the documentation, and are still having trouble installing or operating the software, here are some hints that might help solve the problem. Before attempting any of the following suggestions, please make sure you are familiar with the DOS commands being used. Consult your DOS manual for more information.

For Tandys and other computers with 1 disk drive.

If this game has multiple disks, we recommend you do the following BEFORE installing the game. Insert Disk 1 into your drive.

1. At the A: prompt type B: and press ENTER.
2. Type DIR and press ENTER.
3. Type A: and press ENTER.
4. Type DIR and press ENTER.

You have now put your computer in a two drive emulation mode. When the software asks you to put a disk in drive B:, simply swap the disks, when prompted to do so

TSRs/Device Drivers/DOS shells

TSR stands for Terminate Stay Resident. A TSR is a program, like SideKick® that automatically executes itself when you start up your computer from a hard drive. They are generally installed in your *autoexec.bat* file. Device Drivers and DOS shells also get automatically loaded up. They are usually installed in your *config.sys* file.

These TSRs or Device drivers sometimes interfere with games, or take up valuable memory the game may need, and it is generally recommended that you not run any such programs, device drivers, or shells when attempting to install or play a game.

*DOS Boot Disk*

If you are having trouble installing, experiencing unusual lockups, or other problems that do not appear normal, we suggest you try starting up your system with a DOS Boot disk. Here are the steps for creating a DOS boot disk. Please follow these steps exactly.

1. To create a DOS disk you will need a blank disk the same size as your A: drive.
2. Type C: and press the ENTER Key.
3. Place the blank disk into drive A:

4. Type: Format A:/s

You will be prompted to insert a blank disk into drive A. Do so if you haven't. Press the ENTER key when you are ready.

5. Once the disk is finished formatting you will be asked whether you wish to format another or not. Answer N and press ENTER.

6. You now have a DOS boot disk. You can start your computer from this disk by inserting it into the A: drive and restarting your machine. Your computer will boot up to the A: prompt. This boot disk bypasses the *autoexec.bat* and *config.sys* on your hard drive and starts up your computer in as clean a DOS environment as possible. Try reinstalling the software if you were having trouble doing so, or try starting the software from the drive and directory you installed to. If the software you are trying to run requires a sound driver or mouse driver, don't forget to execute those before starting your game.

## TECHNICAL SUPPORT

If you are still having problems with installing or playing your game, please do not hesitate to contact our Technical Support Department. They can help. If your question is not urgent, please write to us at:

Electronic Arts Technical Support  
P.O. Box 7578  
San Mateo, CA 94403-7578

Please be sure to include the following information in your letter:

- Product name
- Type of computer you own, including make, model, speed (MHz), etc.
- Any additional system information (like type and make of monitor, video card, printer, modem etc.)
- Type of operating system or DOS version number
- Description of the problem you're having

If you need to talk to someone immediately, call us at (415) 572-ARTS Monday through Friday between 8:30 am and 4:30 pm, Pacific Time. Please have the above information ready when you call. This will help us answer your question in the shortest possible time.

If you live outside of the United States, you can contact one of our other offices.

In the United Kingdom, contact: Electronic Arts Limited, P.O. Box 835, Slough SL3 8XU, UK. Phone (753) 546 465.

In Australia, contact: Electronic Arts Pty Ltd. P.O. Box 432, Southport, Qld 4215, Australia.

Within Australia call: (075) 711 811.

Within New Zealand call: +61 75 711 811 between 9am-5pm Eastern Standard Time.

Ad Lib is a registered trademark of Ad Lib Inc.

## NOTICE

ELECTRONIC ARTS RESERVES THE RIGHT TO MAKE IMPROVEMENTS IN THE PRODUCT DESCRIBED IN THIS MANUAL AT ANY TIME AND WITHOUT NOTICE.

THIS MANUAL, AND THE SOFTWARE DESCRIBED IN THIS MANUAL, IS COPYRIGHTED. ALL RIGHTS ARE RESERVED. NO PART OF THIS MANUAL OR THE DESCRIBED SOFTWARE MAY BE COPIED, REPRODUCED, TRANSLATED OR REDUCED TO ANY ELECTRONIC MEDIUM OR MACHINE-READABLE FORM WITHOUT THE PRIOR WRITTEN CONSENT OF ELECTRONIC ARTS, P. O. BOX 7578, SAN MATEO, CALIFORNIA 94403-7578, ATTN: CUSTOMER SERVICE.

ELECTRONIC ARTS MAKES NO WARRANTIES, EXPRESS OR IMPLIED, WITH RESPECT TO THIS MANUAL, ITS QUALITY, MERCHANTABILITY OR FITNESS FOR ANY PARTICULAR PURPOSE. THIS MANUAL IS PROVIDED "AS IS." ELECTRONIC ARTS MAKES CERTAIN LIMITED WARRANTIES WITH REGARD TO THE SOFTWARE AND THE MEDIA FOR THE SOFTWARE. PLEASE SEE THE ELECTRONIC ARTS LIMITED WARRANTY.

SOFTWARE © 1991 ELECTRONIC ARTS  
ALL RIGHTS RESERVED.

MANUAL BY David Luoto

© 1991 ELECTRONIC ARTS. ALL RIGHTS RESERVED.

## **NOTE**

This manual and the software described in it are copyrighted, with all rights reserved. Under the copyright laws, this manual or the software may not be copied, in whole or part, without written consent of Electronic Arts, except in the normal use of the software or to make a backup copy of the software. The same proprietary and copyright notices must be affixed to any permitted copies as were affixed to the original. This exception does not allow copies to be made for others, whether or not sold, but all of the material purchased (with all backup copies) may be sold, given, or loaned to another person. Under the law, copying includes translating into another language or format.

You may use the software on any computer owned by you, but extra copies cannot be made for this purpose.